

TECHNICAL DATA



320COB20WW-2

COB LED STRIP 320D 10W/M 3000K DC24V IP20 25MTS

Flexible LED strip operating at DC24V. Each metre is fitted with 320 COB LED chips and has a power consumption of 10W/m. Colour temperature: 3000K, luminous flux: 990lm/m, IP20 protection rating. Supplied in 25 m reels.



PRODUCT SPECIFICATIONS

Item code:	320COB20WW-2
Description:	COB LED Strip 320D
EAN13 code:	8435724907175

ELECTRICAL DATA

Power:	10w/m
Pins:	2
Dimmable:	YES
Electrical insulation class:	Class III

LUMINOUS DATA

Color temperature:	3000K
Luminous efficiency:	99 lm/w
Lumens:	990lm/m
LED chip model:	COB
Number of LED chips:	320 LEDs per metre
Beam angle:	120°
Light distribution:	Symmetrical
Directional:	Non-directional
Color rendering index:	>90
Luminous maintenance factor:	L95B10

TECHNICAL DATA

Protection rating:	IP20 (Protected against solid objects larger than 12 mm and not protected against liquids)
Operating temperature:	-20°~40°
Mounting type:	Surface
Fixture:	3M adhesive
Maximum connection:	10m

PHYSICAL DATA

Strip	
Material:	PCB + 3M adhesive
Connection:	Includes DC connector at both ends. Transformer required.
Roll length:	25m
Weight	
Weight:	190gr
Dimensions	
PCB:	8mm
Cut segment:	50mm

EFICIENCIA ENERGÉTICA 2023(UE-2019/2015)

F

DIMENSIONS

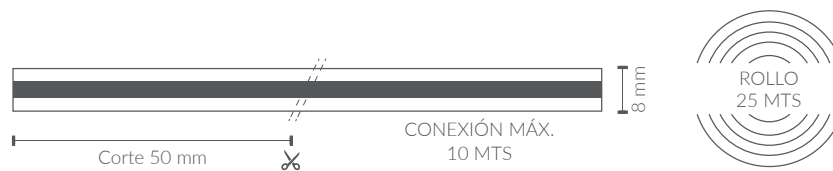

INSTALLATION DIAGRAM

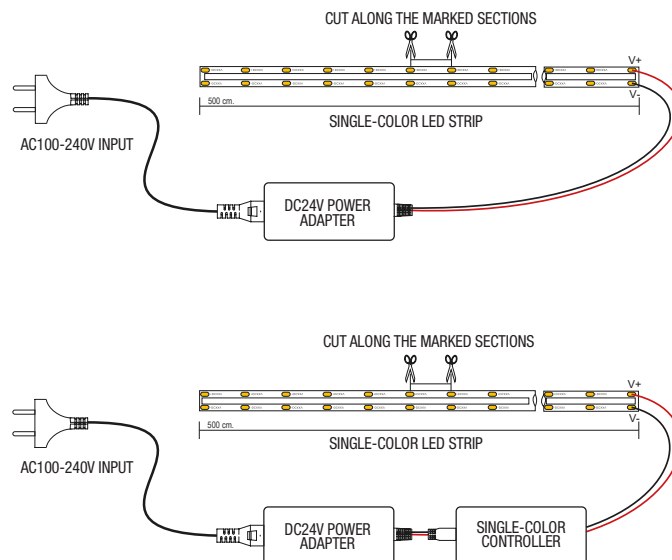

Transformer and single-color controller are not included with the strip.

EMC directive 2014/30/EU ELECTROMAGNETIC COMPATIBILIT

- EN IEC 55015** Limits and measurement methods for radio disturbance characteristics of lighting equipment and similar apparatus.
- EN 61547** General lighting equipment – EMC immunity requirements.
- EN 61000-3-2** Electromagnetic compatibility (EMC). Part 3-2: Limits. Limits for harmonic current emissions (equipment with input current ≤ 16 A per phase). (Approved by the Spanish Association for Standardisation in April 2019.)
- EN 61000-3-3** Electromagnetic compatibility (EMC). Part 3-3: Limits. Limitation of voltage changes, voltage fluctuations and flicker in public low-voltage supply systems for equipment with rated current ≤ 16 A per phase and not subject to conditional connection.

RoHS Directive 2011/65/EU and Delegated Directive (EU) 2015/863

Determination of Certain Substances in Electrotechnical Products.

- IEC 62321-1** **IEC 62321-5**
- IEC 62321-4** **IEC 62321-6**
- IEC 62321-7-1** **IEC 62321-7-2**
- IEC 62321-8**

