

5620002CW

SÉNECA LED FLOODLIGHT 200W 5700K

SÉNECA LED floodlight for outdoor use, 200W power and luminous flux of 29000lm. Equipped with 390 Lumileds LED chips and MOSO MNC-200 series driver, with 6KV surge protection. 120° symmetrical beam angle and 5700K color temperature. IP65 protection rating against external elements and IK08 mechanical impact resistance rating. Aluminum body, galvanized steel fixings, and polycarbonate diffuser. Incorporates an anti-condensation valve to prevent moisture accumulation.



PRODUCT SPECIFICATIONS

Item code:	5620002CW
Description:	LED floodlight for outdoor use
EAN13 code:	8436568445830

ELECTRICAL DATA

Power:	200w
Voltage:	90-305vac
Frequency:	50-60Hz
Power factor:	0,9
Dimmable:	NOT
Driver brand:	MOSO serie MNC 200
Driver protection:	OVP, SCP, OPP, OTP
Overvoltage protection:	Line-to-line 4kV / Line-to-earth 6kV
Electrical insulation class:	CLASS I
Connection:	L/N+TT

LUMINOUS DATA

Color temperature:	5700K
Luminous efficiency:	145 lm/w
Lumens:	29000lm
LED chip brand:	Lumileds
LED chip model:	SMD 2835
N.º LED chip:	390 pcs
Beam angle:	120°
Luminous distribution:	Symmetrical
Color rendering index:	>80
Color rendering index, minimum:	80
Color rendering index, maximum:	85

Standard deviation of colour matching:	<6
Luminous flux maintenance:	L90
Flicker index:	≤1,0
SVM (Stroboscopic Visibility Measure):	≤0,4
Flicker free:	YES

TECHNICAL DATA

Protection rating:	IP65 (Dust-tight equipment and protected against water jets)
Impact rating:	IK08 (5J)
Operating temperature:	-25°~45°
Mounting type:	Surface
Oscillation of the lira:	300°
Goniometer:	YES
Anti-condensation Valve:	YES

AVERAGE LIFESPAN

Working hours:	55000 hrs
Switching cycles:	35000 ON/OFF

PHYSICAL DATA

Housing

Material:	Aluminum
Finish:	Beige gray
RAL:	7006

Yoke and side plates

Material:	Galvanized zinc-coated Steel
Finish:	Black

Diffuser

Material:	Polycarbonate
Finish:	Transparent

Weight

Weight:	5,05 kg
---------	---------

ENERGY EFFICIENCY 2023(UE-2019/2015)

E

DIMENSIONS

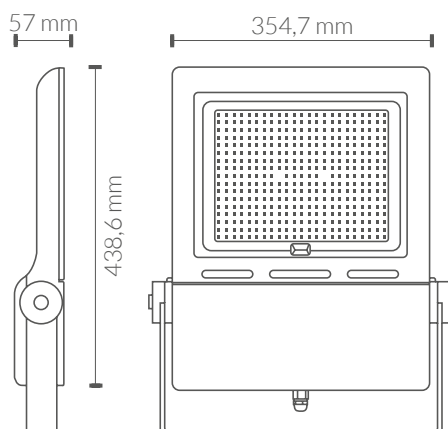

LUMINOUS INTENSITY DISTRIBUTION CURVE

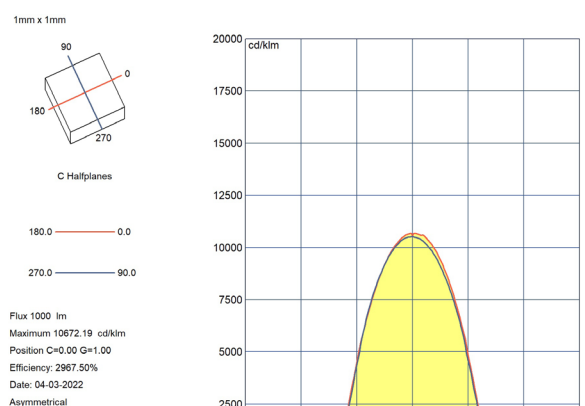
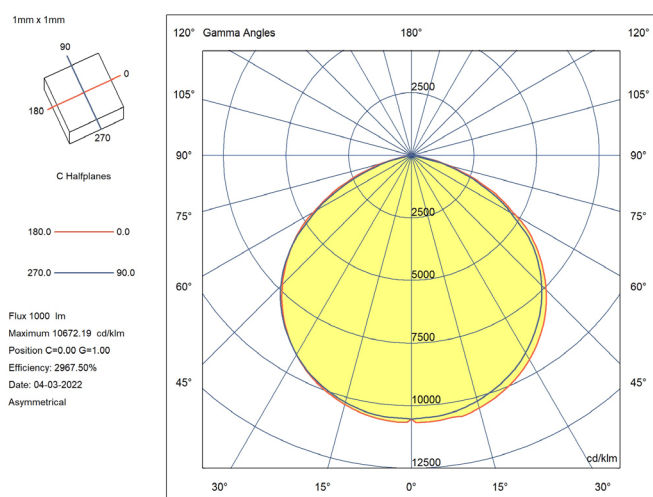

CERTIFICATIONS

CE & ROHS

EMC directive 2014/30/EU ELECTROMAGNETIC COMPATIBILIT

- EN IEC 55015** Limits and methods of measurement of radio disturbance characteristics of electrical lighting and similar equipment.
- EN IEC 61000-3-2** Electromagnetic compatibility (EMC) - Part 3-2: Limits - Limits for harmonic current emissions (equipment input current =16 A per phase).
- EN 61000-3-3** Electromagnetic compatibility (EMC) - Part 3-3: Limits - Limitation of voltage changes, voltage fluctuations and flicker in public low-voltage supply systems, for equipment with rated current ≤ 16 A per phase and not subject to conditional connection.
- EN 61547** Equipment for general lighting purposes - EMC immunity requirements.
- LVD directive 2014/35/EU LOW VOLTAGE**
- EN 60598-2-5** Luminaires - Part 2-5: Particular requirements - Floodlights
- EN 60598-1** Luminaires - Part 1: General requirements and tests.
- EN 62493** Assessment of lighting equipment related to human exposure to electromagnetic Field

RoHS Directive 2011/65/EU and Delegated Directive (EU) 2015/863

Determination of Certain Substances in Electrotechnical Products.

- | | | |
|----------------------|----------------------|----------------------|
| IEC 62321-2 | IEC 62321-3-1 | IEC 62321-4 |
| IEC 62321-5 | IEC 62321-6 | IEC 62321-7-2 |
| IEC 62321-7-1 | IEC 62321-8 | |

