

561500312CW

PÓPULO LED FLOODLIGHT 150W 5700K 120°

PÓPULO LED floodlight for outdoor use, 150W power and luminous flux of 21750lm. Equipped with 192 Lumileds LED chips and driver with 4KV surge protection. 120° symmetrical optical beam angle and 5700K color temperature. IP66 protection rating against external elements and IK08 mechanical impact resistance rating. Aluminum body and polycarbonate lens. Incorporates an anti-condensation valve to prevent moisture accumulation.



PRODUCT SPECIFICATIONS

Item code:	561500312CW
Description:	LED floodlight for outdoor use
EAN13 code:	8435724800209

ELECTRICAL DATA

Power:	150w
Voltage:	175-265vac
Frequency:	50-60 Hz
Power factor:	0,9
Dimmable:	NOT
Driver Protection:	OVP, SCP, OPP, OTP
Overvoltage protection:	4kv
Electrical insulation class:	CLASS I
Connection:	L/N+TT

LUMINOUS DATA

Color temperature:	5700K
Luminous efficiency:	145 lm/w
Lumens:	21750lm
LED chip brand:	Lumileds
LED chip model:	SMD2835
N.º LED chip:	192pcs
Beam angle:	120°
Luminous distribution:	Symmetrical
Color rendering index:	>80
Color rendering index, minimum:	80
Color rendering index, maximum:	85
Standard desviation of colour matching:	<6

Luminous flux maintenance:	L90
Flicker index:	≤1,0
SVM (Stroboscopic Visibility Measure):	≤0,4
Flicker free:	YES

TECHNICAL DATA

Protection rating:	IP65 (Dust-tight equipment and protected against water jets)
Impact rating:	IK08 (5J)
Operating temperature:	-20°~50°
Mounting type:	Surface
Anti-condensation Valve:	YES

AVERAGE LIFESPAN

Working hours:	55000 hrs
Switching cycles:	35000 ON/OFF

PHYSICAL DATA

Housing	
Material:	Aluminum
Finish:	Black
Diffuser	
Material:	Glass
Finish:	Transparent
Weight	
Weight:	3,50 kg

ENERGY EFFICIENCY 2023(UE-2019/2015)

E

DIMENSIONS

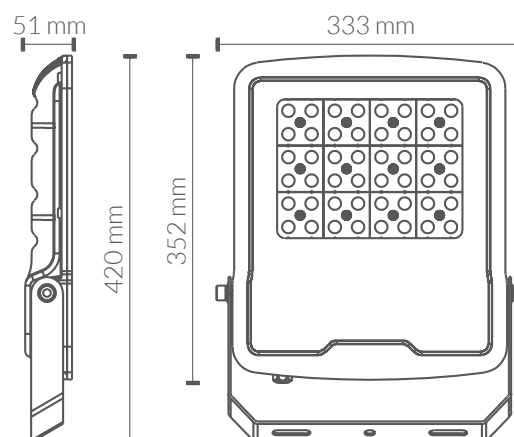

LUMINOUS INTENSITY DISTRIBUTION CURVE

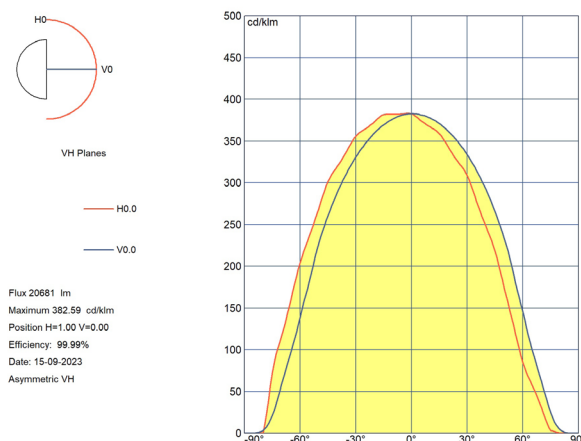
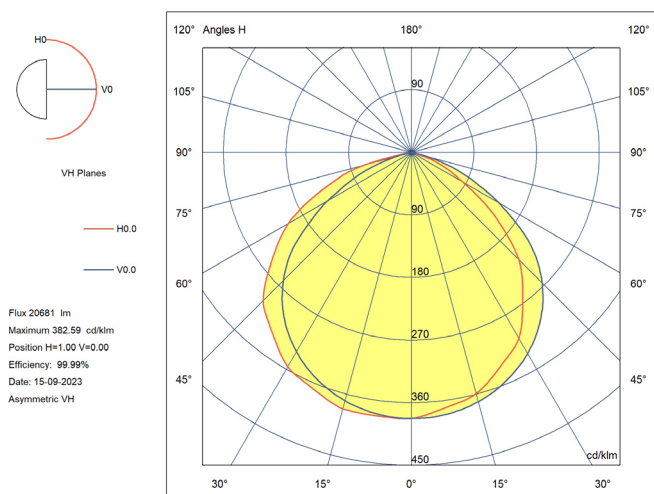

CERTIFICATIONS

CE & ROHS

EMC directive 2014/30/EU ELECTROMAGNETIC COMPATIBILITY

- EN IEC 55015** Limits and methods of measurement of radio disturbance characteristics of electrical lighting and similar equipment.
- EN IEC 61000-3-2** Electromagnetic compatibility (EMC) - Part 3-2: Limits - Limits for harmonic current emissions (equipment input current =16 A per phase).
- EN 61000-3-3** Electromagnetic compatibility (EMC) - Part 3-3: Limits - Limitation of voltage changes, voltage fluctuations and flicker in public low-voltage supply systems, for equipment with rated current ≤ 16 A per phase and not subject to conditional connection.
- EN 61547** Equipment for general lighting purposes - EMC immunity requirements.

LVD directive 2014/35/EU LOW VOLTAGE

- EN 60598-2-5** Luminaires - Part 2-5: Particular requirements - Floodlights
- EN 60598-1** Luminaires - Part 1: General requirements and tests.
- EN 62471** Photobiological safety of lamps and lamp system
- EN 62493** Assessment of lighting equipment related to human exposure to electromagnetic Field
- EN 62031** LED modules for general lighting. Safety specifications
- EN 61347-1** Lamp controlgear - Part 1: General and safety requirements
- EN 61347-2-13** Lamp controlgear - Part 2-13: Particular requirements for d.c. or a.c. supplied electronic controlgear for LED modules

RoHS Directive 2011/65/EU and Delegated Directive (EU) 2015/863

Determination of Certain Substances in Electrotechnical Products.

- | | | | |
|----------------------|----------------------|--------------------|------------------------|
| IEC 62321-3-1 | IEC 62321-5 | IEC 62321-4 | CSV IEC 62321-6 |
| IEC 62321-7-1 | IEC 62321-7-2 | IEC 62321-8 | |

