

561000312WW

## PÓPULO LED FLOODLIGHT 100W 3000K 120°

PÓPULO LED floodlight for outdoor use, 100W power and luminous flux of 14100lm. Equipped with 144 Lumileds LED chips and driver with 4KV surge protection. 120° symmetrical optical beam angle and 3000K color temperature. IP66 protection rating against external elements and IK08 mechanical impact resistance rating. Aluminum body and polycarbonate lens. Incorporates an anti-condensation valve to prevent moisture accumulation.



### PRODUCT SPECIFICATIONS

Item code:	561000312WW
Description:	LED floodlight for outdoor use
EAN13 code:	8435724900787

### ELECTRICAL DATA

Power:	100w
Voltage:	175-265vac
Frequency:	50-60 Hz
Power factor:	0,9
Dimmable:	NOT
Driver Protection:	OVP, SCP, OPP, OTP
Overvoltage protection:	4kv
Electrical insulation class:	CLASS I
Connection:	L/N+TT

### LUMINOUS DATA

Color temperature:	3000K
Luminous efficiency:	141 lm/w
Lumens:	14100lm
LED chip brand:	Lumileds
LED chip model:	SMD2835
N.º LED chip:	144pcs
Beam angle:	120°
Luminous distribution:	Symmetrical
Color rendering index:	>80
Color rendering index, minimum:	80
Color rendering index, maximum:	85
Standard desviation of colour matching:	<6

Luminous flux maintenance:	L90
Flicker index:	≤1,0
SVM (Stroboscopic Visibility Measure):	≤0,4
Flicker free:	YES

## TECHNICAL DATA

Protection rating:	IP65 (Dust-tight equipment and protected against water jets)
Impact rating:	IK08 (5J)
Operating temperature:	-20°~50°
Mounting type:	Surface
Anti-condensation Valve:	YES

## AVERAGE LIFESPAN

Working hours:	55000 hrs
Switching cycles:	35000 ON/OFF

## PHYSICAL DATA

<b>Housing</b>	
Material:	Aluminum
Finish:	Black
<b>Diffuser</b>	
Material:	Glass
Finish:	Transparent
<b>Weight</b>	
Weight:	1,72 kg

## ENERGY EFFICIENCY 2023(UE-2019/2015)

**E**

## DIMENSIONS

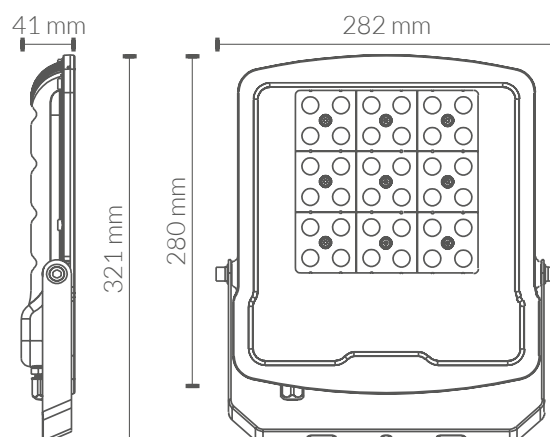

## LUMINOUS INTENSITY DISTRIBUTION CURVE

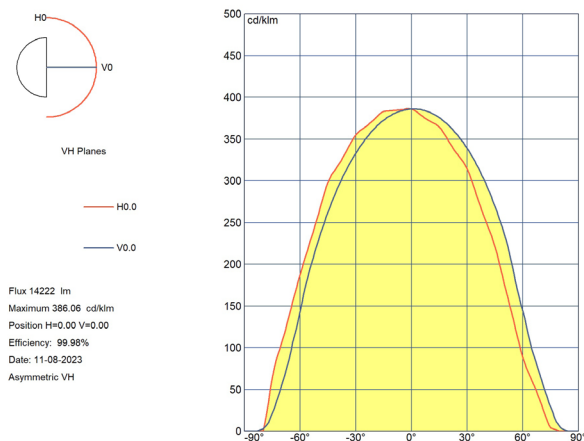
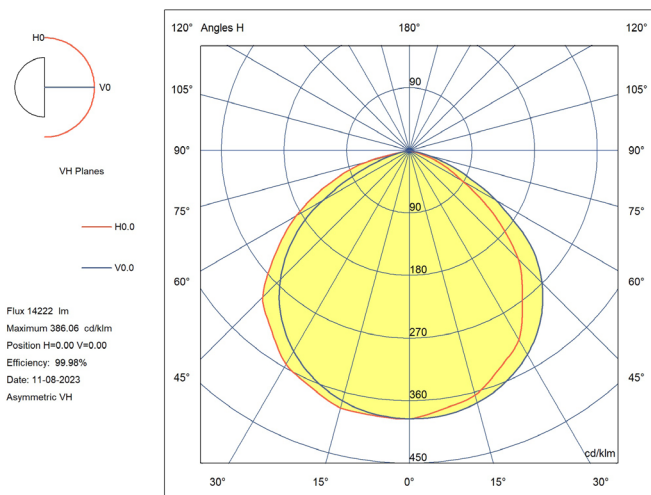

## CERTIFICATIONS

CE & ROHS

### EMC directive 2014/30/EU ELECTROMAGNETIC COMPATIBILITY

- EN IEC 55015** Limits and methods of measurement of radio disturbance characteristics of electrical lighting and similar equipment.
- EN IEC 61000-3-2** Electromagnetic compatibility (EMC) - Part 3-2: Limits - Limits for harmonic current emissions (equipment input current =16 A per phase).
- EN 61000-3-3** Electromagnetic compatibility (EMC) - Part 3-3: Limits - Limitation of voltage changes, voltage fluctuations and flicker in public low-voltage supply systems, for equipment with rated current  $\leq 16$  A per phase and not subject to conditional connection.
- EN 61547** Equipment for general lighting purposes - EMC immunity requirements.

### LVD directive 2014/35/EU LOW VOLTAGE

- EN 60598-2-5** Luminaires - Part 2-5: Particular requirements - Floodlights
- EN 60598-1** Luminaires - Part 1: General requirements and tests.
- EN 62471** Photobiological safety of lamps and lamp system
- EN 62493** Assessment of lighting equipment related to human exposure to electromagnetic Field
- EN 62031** LED modules for general lighting. Safety specifications
- EN 61347-1** Lamp controlgear - Part 1: General and safety requirements
- EN 61347-2-13** Lamp controlgear - Part 2-13: Particular requirements for d.c. or a.c. supplied electronic controlgear for LED modules

### RoHS Directive 2011/65/EU and Delegated Directive (EU) 2015/863

Determination of Certain Substances in Electrotechnical Products.

- IEC 62321-3-1**      **IEC 62321-5**      **IEC 62321-4**      **CSV IEC 62321-6**
- IEC 62321-7-1**      **IEC 62321-7-2**      **IEC 62321-8**

