

TECHNICAL DATA SHEET



555030SCCT

LED FLOODLIGHT KADO WITH SENSOR 50W CCT

LED Floodlight KADO CCT with sensor for outdoor use, 50W power and 6000lm luminous flux. Equipped with 120 LUMILEDS LED chips. Symmetrical 90° optical beam angle and 3 selectable color temperatures via remote control. Protection rating against external elements IP65 and mechanical impact resistance rating IK09. Housing made of aluminum with gray finish and transparent polycarbonate lens.



PRODUCT SPECIFICATIONS

Item code:	555030SCCT
Description:	LED Floodlight for Outdoor Use
EAN13 code:	8435724907823

ELECTRICAL DATA

Power:	50W
Voltage:	90-265VAC
Frequency:	50-60 Hz
Power factor:	0,9
Dimmable:	NOT
Electrical insulation class:	CLASS I
Connection:	L/N+TT

LUMINOUS DATA

Color temperature:	Selectable CCT 5700K/4000K/3000K
Color temperature selection mode:	Remote control unit
Luminous efficiency:	120lm/w
Lumens:	6000lm
LED chip brand:	LUMILEDS
LED chip model:	SMD 2835
N.° of LED chips:	120 pcs
Beam angle:	90°
Luminous distribution:	Symmetrical
Color rendering index:	>80
Minimum color rendering index:	80
Maximum color rendering index:	85

Standard deviation of colour matching:	<4
Luminous flux maintenance:	L90
Flicker index:	≤1,0
SVM (Stroboscopic Visibility Measure):	≤0,9
Flicker free:	YES

TECHNICAL DATA

Protection rating:	IP65 (Dust-tight equipment and protected against water jets)
Impact rating:	IK09 (10J)
Operating temperature:	-20°~50°
Mounting type:	Surface

AVERAGE LIFESPAN

Working hours:	45000 hrs
Switching cycles:	35000 ON/OFF

DATOS SENSOR

Sensor type:	Microwave
Work mode:	ALLDAY: Sensor operation 24 hours NIGHT: Sensor operation during night-time only
Configuration options:	YES
Detection range:	2mt, 4mt, 6mt, 8mt.
Detection angle:	150°
Hold time:	30s, 90s, 3min, 5min, 10min.
Mounting height:	Máx. 6 mt.
Configuration options:	Remote control unit

PHYSICAL DATA

Housing	
Material:	Aluminum
Finish:	Gray
Optical	
Material:	Polycarbonate (PC)
Finish:	Transparent
Weight	
Weight:	0,5 kg

DIMENSIONS

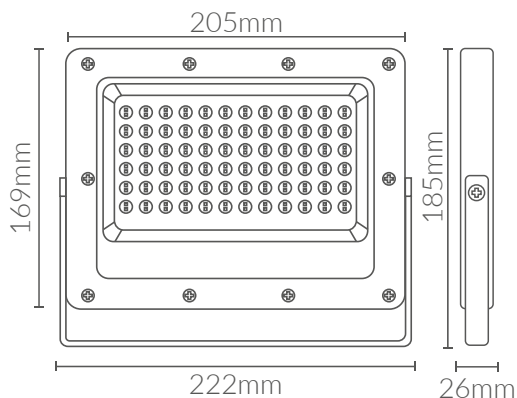

CERTIFICATIONS

CE & ROHS

Directiva EMC 2014/30/EU ELECTROMAGNETIC COMPATIBILIT

- EN IEC 55015** Limits and methods of measurement of radio disturbance characteristics of electrical lighting and similar equipment.
- EN IEC 61000-3-2** Electromagnetic compatibility (EMC) - Part 3-2: Limits - Limits for harmonic current emissions (equipment input current =16 A per phase).
- EN 61000-3-3** Electromagnetic compatibility (EMC) - Part 3-3: Limits - Limitation of voltage changes, voltage fluctuations and flicker in public low-voltage supply systems, for equipment with rated current ≤ 16 A per phase and not subject to conditional connection.
- EN 61547** Equipment for general lighting purposes - EMC immunity requirements.

Directiva LVD 2014/35/EU LOW VOLTAGE

- EN 60598-2-5** Luminaires. Part 2-5: Particular requirements. Floodlights.
- EN 60598-1** Luminaires. Part 1: General requirements and tests.

RoHS Directive 2011/65/EU and Delegated Directive (EU) 2015/863

Determination of Certain Substances in Electrotechnical Products.

- IEC 62321-1** **IEC 62321-1-2**
- IEC 62321-3-1** **IEC 62321-4**
- IEC 62321-6** **IEC 62321-7-1**
- IEC 62321-7-2** **IEC 62321-8**

