

561000WW

GADES LED FLOODLIGHT 10W 3000K

GADES LED floodlight for outdoor use, 10W power and luminous flux of 850lm. 120° symmetrical optical beam angle and 3000K color temperature. IP65 protection rating against external elements and IK08 mechanical impact resistance rating. Made of white finish aluminum.



PRODUCT SPECIFICATIONS

Item code:	561000WW
Description:	LED floodlight for outdoor use
EAN13 code:	8436568444116

ELECTRICAL DATA

Power:	10w
Voltage:	220-240vac
Frequency:	50-60 Hz
Power factor:	0,9
Dimmable:	NOT
Electrical insulation class:	CLASS I
Connection:	L/N+TT

LUMINOUS DATA

Color temperature:	3000K
Luminous efficiency:	85lm/w
Lumens:	850lm
LED chip model:	SMD 2835
Beam angle:	120°
Luminous distribution:	Symmetrical
Color rendering index:	>80
Color rendering index, minimum:	80
Color rendering index, maximum:	85
Standard deviation of colour matching:	<4
Luminous flux maintenance:	L90
Flicker index:	≤1,0
SVM (Stroboscopic Visibility Measure):	≤0,9

TECHNICAL DATA

Protection rating:	IP65 (Dust-tight equipment and protected against water jets)
Impact rating:	IK08 (5J)
Operating temperature:	-20°~50°
Mounting type:	Surface

AVERAGE LIFESPAN

Working hours:	45000 hrs
Switching cycles:	35000 ON/OFF

PHYSICAL DATA

Housing	
Material:	Aluminum
Finish:	White
Diffuser	
Material:	Glass
Finish:	Transparent
Weight	
Weight:	0,24 kg

ENERGY EFFICIENCY 2023(UE-2019/2015)

F

DIMENSIONS

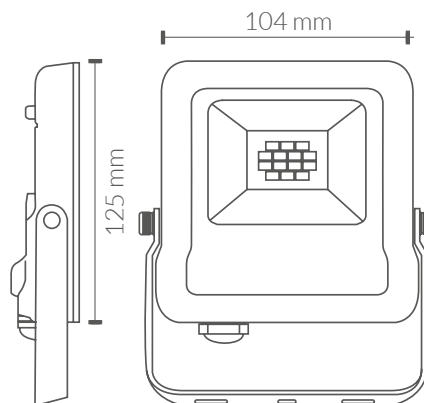

LUMINOUS INTENSITY DISTRIBUTION CURVE

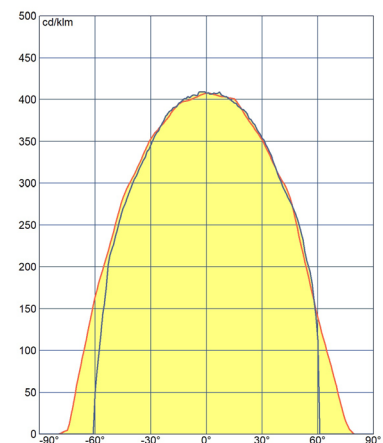
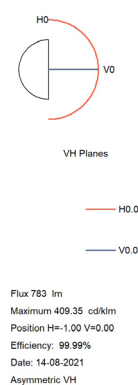
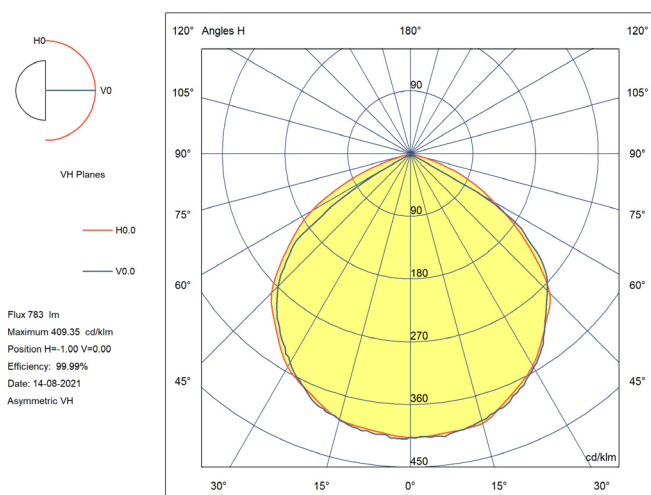

EMC directive 2014/30/EU ELECTROMAGNETIC COMPATIBILIT

- EN IEC 55015** Limits and methods of measurement of radio disturbance characteristics of electrical lighting and similar equipment.
- EN IEC 61000-3-2** Electromagnetic compatibility (EMC) - Part 3-2: Limits - Limits for harmonic current emissions (equipment input current =16 A per phase).
- EN 61000-3-3** Electromagnetic compatibility (EMC) - Part 3-3: Limits - Limitation of voltage changes, voltage fluctuations and flicker in public low-voltage supply systems, for equipment with rated current ≤ 16 A per phase and not subject to conditional connection.
- EN 61547** Equipment for general lighting purposes - EMC immunity requirements.

LVD directive 2014/35/EU LOW VOLTAGE

- EN 60598-2-5** Luminaires - Part 2-5: Particular requirements - Floodlights
- EN 60598-1** Luminaires - Part 1: General requirements and tests.
- EN 62471** Photobiological safety of lamps and lamp system
- EN 62493** Assessment of lighting equipment related to human exposure to electromagnetic Field
- EN 62031:** LED modules for general lighting. Safety specifications
- EN 61347-1** Lamp controlgear - Part 1: General and safety requirements
- EN 61347-2-13** Lamp controlgear - Part 2-13: Particular requirements for d.c. or a.c. supplied electronic controlgear for LED modules

RoHS Directive 2011/65/EU and Delegated Directive (EU) 2015/863

Determination of Certain Substances in Electrotechnical Products.

- IEC 62321-3-1** **IEC 62321-5**
- IEC 62321-4** **IEC 62321-6**
- IEC 62321-7-1** **IEC 62321-7-2**
- IEC 62321-8**

