

5515030WW

KADO LED FLOODLIGHT 150W 3000K

KADO LED floodlight for outdoor use, 150W power and luminous flux of 17400lm. Equipped with 216 LUMILEDS LED Chips, and Linear Driver with 4Kv surge protection. 90° symmetrical optical beam angle and 3000K color temperature. IP65 protection rating against external elements and IK09 mechanical impact resistance rating. Body made of grey finish aluminum and transparent polycarbonate lens.



PRODUCT SPECIFICATIONS

Item code:	5515030WW
Description:	LED floodlight for outdoor use
EAN13 code:	8435724903313

ELECTRICAL DATA

Power:	150w
Voltage:	185-265vac
Frequency:	50-60 Hz
Power factor:	0,9
Driver model:	Lineal Driver
Overvoltage protection:	4 Kv
Dimmable:	NOT
Electrical insulation class:	CLASS I
Connection:	L/N+TT

LUMINOUS DATA

Color temperature:	3000K
Luminous efficiency:	116lm/w
Lumens:	17400lm
LED chip brand:	LUMILEDS
LED chip model:	SMD 2835
N.º LED chip:	216 pcs
Beam angle:	90°
Luminous distribution:	Symmetrical
Color rendering index:	>80
Color rendering index, minimum:	80
Color rendering index, maximum:	85

Standard deviation of colour matching:	<4
Luminous flux maintenance:	L90
Flicker index:	≤1,0
SVM (Stroboscopic Visibility Measure):	≤0,9
Flicker free:	YES

TECHNICAL DATA

Protection rating:	IP65 (Dust-tight equipment and protected against water jets)
Impact rating:	IK09 (10J)
Operating temperature:	-20°~50°
Mounting type:	Surface

AVERAGE LIFESPAN

Working hours:	45000 hrs
Switching cycles:	35000 ON/OFF

PHYSICAL DATA

Housing	
Material:	Aluminum
Finish:	Gray
Diffuser	
Material:	Polycarbonate (PC)
Finish:	Transparent
Weight	
Weight:	0,94 kg

ENERGY EFFICIENCY 2023(UE-2019/2015)

F

DIMENSIONS

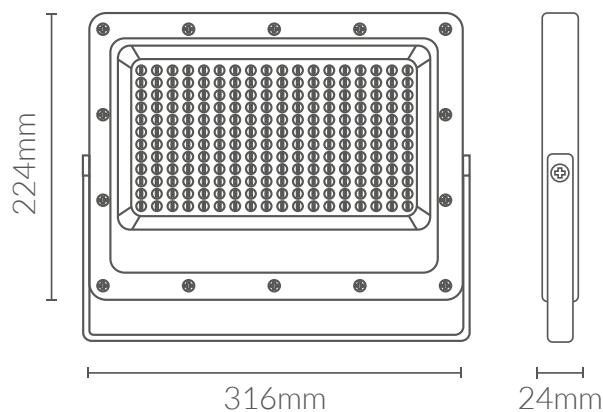

LUMINOUS INTENSITY DISTRIBUTION CURVE

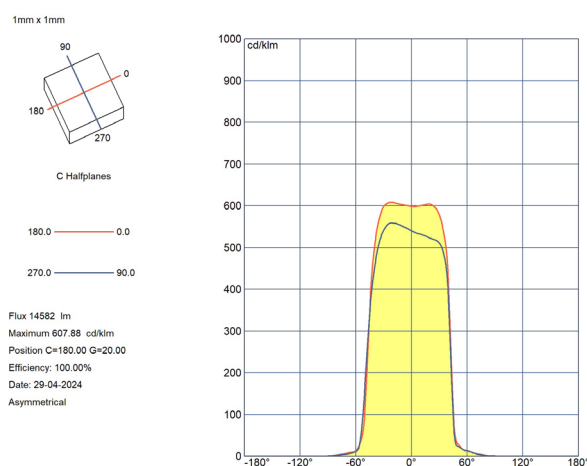
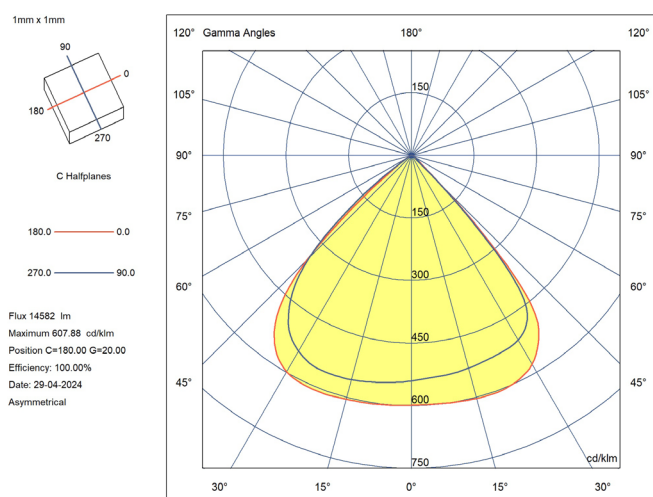

CERTIFICATIONS

CE & ROHS

EMC directive 2014/30/EU ELECTROMAGNETIC COMPATIBILITY

- EN IEC 55015** Limits and methods of measurement of radio disturbance characteristics of electrical lighting and similar equipment.
- EN IEC 61000-3-2** Electromagnetic compatibility (EMC) - Part 3-2: Limits - Limits for harmonic current emissions (equipment input current =16 A per phase).
- EN 61000-3-3** Electromagnetic compatibility (EMC) - Part 3-3: Limits - Limitation of voltage changes, voltage fluctuations and flicker in public low-voltage supply systems, for equipment with rated current ≤ 16 A per phase and not subject to conditional connection.
- EN 61547** Equipment for general lighting purposes - EMC immunity requirements.

LVD directive 2014/35/EU LOW VOLTAGE

- EN 60598-2-5** Luminaires - Part 2-5: Particular requirements - Floodlights
- EN 60598-1** Luminaires - Part 1: General requirements and tests.

RoHS Directive 2011/65/EU and Delegated Directive (EU) 2015/863

Determination of Certain Substances in Electrotechnical Products.

- IEC 62321-1** **IEC 62321-1-2**
- IEC 62321-3-1** **IEC 62321-4**
- IEC 62321-6** **IEC 62321-7-1**
- IEC 62321-7-2** **IEC 62321-8**

