

L128N150N

MELKART LED EMERGENCY LUMINAIRE 150LM NON-MAINTAINED

Melkart LED emergency luminaire, non-maintained operation. Provides 180 minutes of autonomy and a luminous flux of 150lm with a 5700K colour temperature. IP20 protection rating against external elements and IK06 mechanical impact resistance rating. Luminaire manufactured from white ABS with an opal polymethyl methacrylate diffuser.



PRODUCT SPECIFICATIONS

Item code:	L128N150N
Description:	Melkart LED emergency luminaire
EAN13 code:	8435724903450

ELECTRICAL DATA

Power:	1w
Voltage:	220/240vac
Frequency:	50/60Hz
Electrical insulation class:	CLASs II
Connection:	L/N
Function:	Non-maintained

LUMINOUS DATA

Color temperature:	5700K
Lumens:	150lm
LED chip model:	SMD 2835
N.° LED chip:	16pcs
Beam angle:	120°
Luminous distribution:	Symmetrical

TECHNICAL DATA

Protection rating:	IP20 (Protected against solid objects larger than 12 mm in diameter)
Impact rating:	IK06 (1J)
Operating temperature:	-10°~55°
Mounting type:	Surface-mounted / Recessed ceiling installation (accessory sold separately) / Wall-recessed installation (accessory sold separately)
Battery:	NP-Li-On 3,7V/1,3Ah
Replaceable Battery:	NOT
Autonomy:	180 minutes

PHYSICAL DATA

Housing	
Material:	ABS
Finish:	White
Diffuser	
Material:	Polymethyl methacrylate (PMMA)
Finish:	Opal
Weight	
Weight:	0,25 kg

ENERGY EFFICIENCY 2023(UE-2019/2015)

F

DIMENSIONS

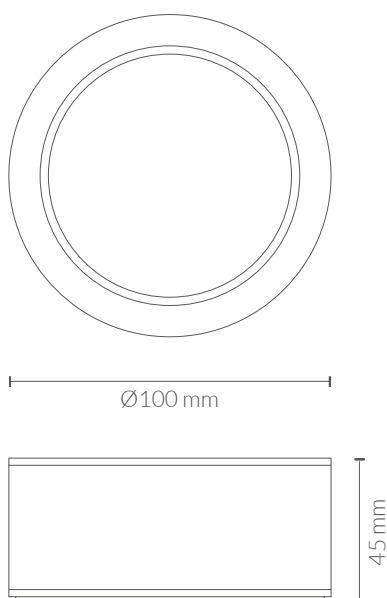

LUMINOUS INTENSITY DISTRIBUTION CURVE

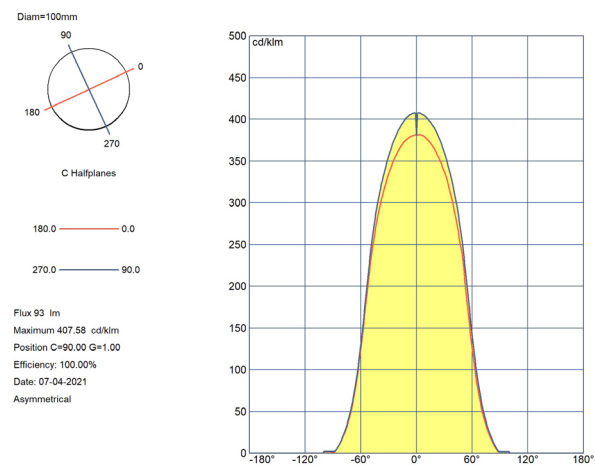
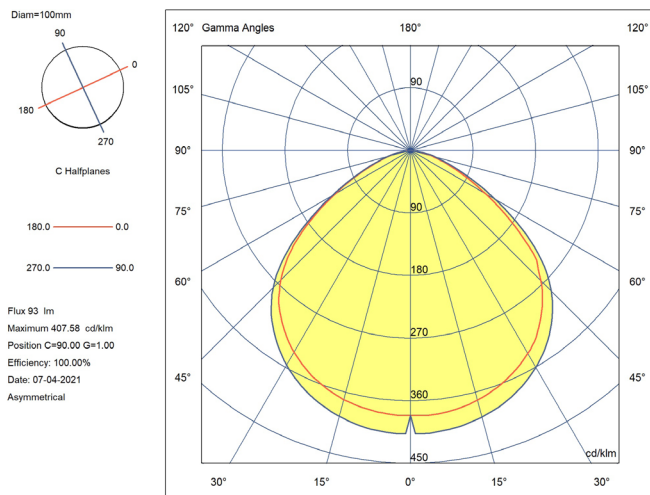

CERTIFICATIONS

CE & ROHS

Directiva EMC 2014/30/EU ELECTROMAGNETIC COMPATIBILIT

- EN IEC 55015** Limits and methods of measurement of radio disturbance characteristics of electrical lighting and similar equipment.
- EN 61547:** Equipment for general lighting purposes - EMC immunity requirements.
- EN IEC 61000-3-2** Electromagnetic compatibility (EMC) - Part 3-2: Limits - Limits for harmonic current emissions (equipment input current =16 A per phase).
- EN 61000-3-3** Electromagnetic compatibility (EMC) - Part 3-3: Limits - Limitation of voltage changes, voltage fluctuations and flicker in public low-voltage supply systems, for equipment with rated current ≤ 16 A per phase and not subject to conditional connection.

Directiva LVD 2014/35/EU LOW VOLTAGE

- EN IEC 60598-2-22** Luminaires. Part 2-22: Particular requirements. Luminaires for emergency lighting.
- EN IEC 60598-1** Luminaires. Part 1: General requirements and tests.

RoHS Directive 2011/65/EU and Delegated Directive (EU) 2015/863

Determination of Certain Substances in Electrotechnical Products.

- IEC 62321-1** **IEC 62321-2**
- IEC 62321-3-1** **IEC 62321-3-2**
- IEC 62321-4** **IEC 62321-5**
- IEC 62321-6** **IEC 62321-7-1**
- IEC 62321-8**

