

261830CWDIM

ROUND SURFACE-MOUNTED DIMMABLE LED DOWNLIGHT 18W 6000K MATT CHROME



PRODUCT SPECIFICATIONS

Item code:	261830CWDIM
Description:	Surface-mounted round LED downlight
EAN13 code:	8436568443034

ELECTRICAL DATA

Power:	18w
Voltage:	200/250vac
Frequency:	50/60Hz
Overvoltage protection:	2 kv
Power factor:	0,9
Dimmable:	YES
Dimming system:	TRIAC
Electrical insulation class:	CLASS II
Connection:	L/N

LUMINOUS DATA

Color temperature:	6000K
Luminous efficiency:	100 lm/w
Lumens:	1800lm
LED chip brand:	San'an
LED chip model:	SMD2835
Beam angle:	180°
Luminous distribution:	Symmetrical
Color rendering index:	>80
Standard deviation of colour matching:	<6
Luminous maintenance factor:	L95
Flicker index:	≤1,0
SVM (Stroboscopic Visibility Measure):	≤0,4

TECHNICAL DATA

Protection rating:	IP44 (Equipment protected against objects larger than 1 mm and splashing water)
Impact rating:	IK06 (1J)
Operating temperature:	-20°~50°
Mounting type:	Surface mounting

AVERAGE LIFESPAN

Working hours:	40000 hrs
Switch cycles:	35000 ON/OFF

PHYSICAL DATA

Housing	
Material:	Aluminium
Finish:	Matt Chrome
Diffuser	
Material:	Polycarbonate
Finish:	Opal
Weight	
Weight:	0,42 kg

ENERGY EFFICIENCY 2023(UE-2019/2015)

F

DIMENSIONS

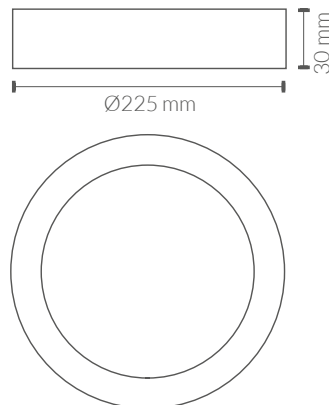

LUMINOUS INTENSITY DISTRIBUTION CURVE

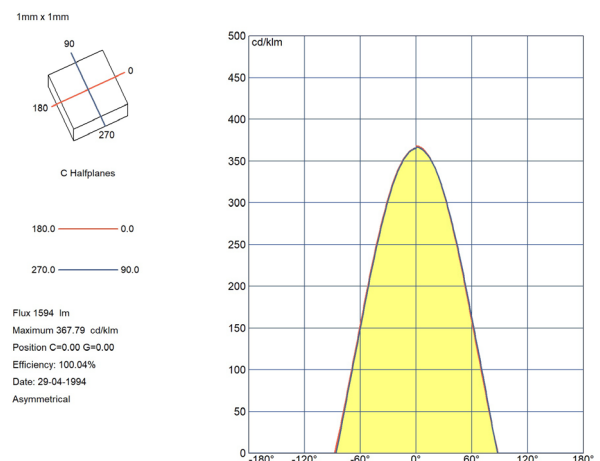
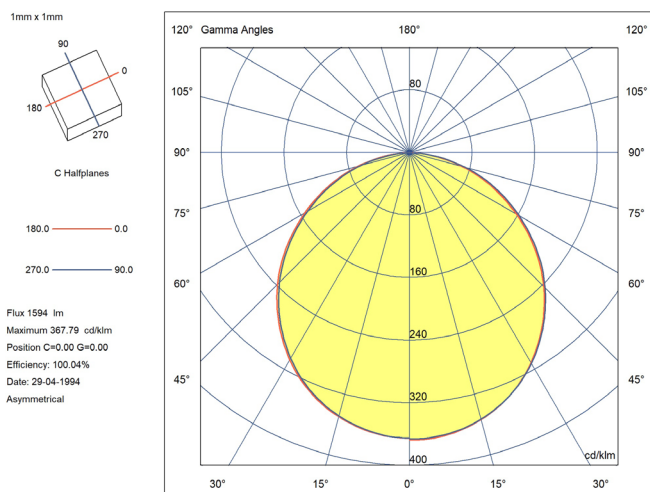

EMC Directive 2014/30/EU ELECTROMAGNETIC COMPATIBILITY

- EN IEC 55015** Limits and methods of measurement of radio disturbance characteristics of electrical lighting and similar equipment.
- EN IEC 61000-3-2** Electromagnetic compatibility (EMC) - Part 3-2: Limits - Limits for harmonic current emissions (equipment input current =16 A per phase).
- EN 61000-3-3** Electromagnetic compatibility (EMC) - Part 3-3: Limits - Limitation of voltage changes, voltage fluctuations and flicker in public low-voltage supply systems, for equipment with rated current ≤ 16 A per phase and not subject to conditional connection.
- EN 61547:** Equipment for general lighting purposes - EMC immunity requirements.

LVD Directive 2014/35/EU LOW VOLTAGE

- EN IEC 60598-1** Luminaires - Part 1: General requirements and tests.
- EN IEC 60598-2-1** Luminaires - Part 2-1: Particular requirements - Fixed general purpose luminaires

RoHS Directive 2011/65/EU and Delegated Directive (EU) 2015/863

Determination of certain substances in electrotechnical products.

- IEC 62321-1** **IEC 62321-3-1**
- IEC 62321-4** **IEC 62321-5**
- IEC 62321-6** **IEC 62321-7-1**
- IEC62321-7-2** **IEC 62321-8**

