

441800WW

RECESSED SQUARE LED DOWNLIGHT 18W 3000K WHITE



PRODUCT DATES

Item code:	441800WW
Description:	Recessed square LED downlight
EAN13 code:	8436568440903

ELECTRICAL DATA

Power:	18w
Voltage:	85/265vac
Frequency:	50/60Hz
Surge protection:	2 kv
Power factor:	0,5
Dimable:	NO
Electrical insulation class:	CLASS II
Connection:	L/N

LIGHTING DATA

Color temperature:	3000K
Lighting efficiency:	96 lm/w
Lumens:	1728lm
Brand LED chip:	San'an
LED chip model:	SMD2835
Beam angle:	180°
Light distribution:	Symmetrical
Colour rendering index:	>80
Standard chromatic deviation:	<6
Luminous maintenance factor:	L95B10
Flicker index:	≤1,0
Strobe effect visibility measurement:	≤0,4

TECHNICAL DATA

Degree of protection:	IP44 (Equipment protected against objects larger than 1 mm and splashing water)
Degree of impact:	IK06 (1J)
Operating temperature:	-20°~50°
Mounting type:	Recessed mounting

LIFE TIME

Working hours:	40000 hrs
Switch cycles:	35000 ON/OFF

PHYSICAL DATA

Housing	
Material:	Aluminium
Finish:	White
Diffuser	
Material:	Polycarbonate
Finish:	Opal
Weight	
Weight:	0,38 kg

ENERGY EFFICIENCY 2023 (EU-2019/2015)

F

MEASURES

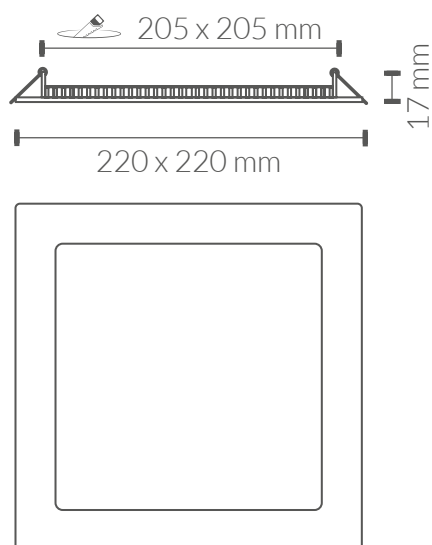

LIGHT INTENSITY DISTRIBUTION CURVE

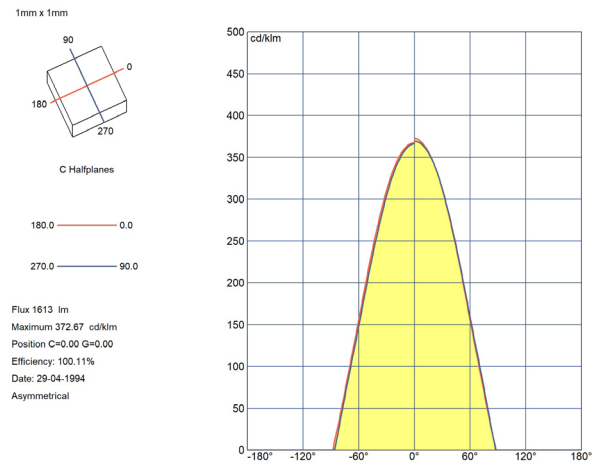
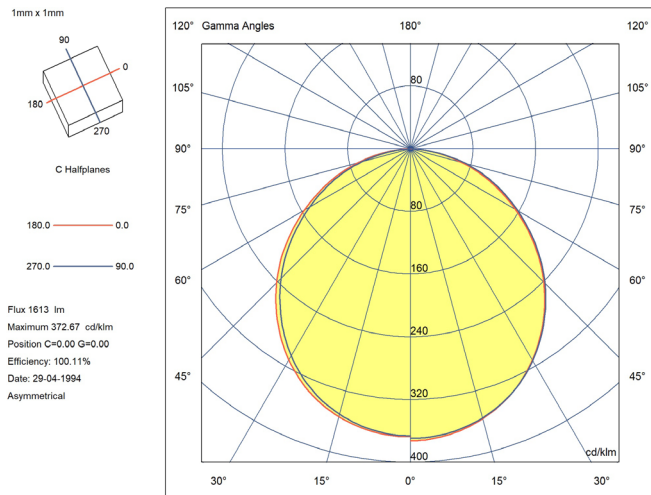

CERTIFICATIONS

CE & ROHS

EMC Directive 2014/30/EU ELECTROMAGNETIC COMPATIBILITY

- EN IEC 55015** Limits and methods of measurement of radio disturbance characteristics of electrical lighting and similar equipment.
- EN IEC 61000-3-2** Electromagnetic compatibility (EMC) - Part 3-2: Limits - Limits for harmonic current emissions (equipment input current = 16 A per phase).
- EN 61000-3-3** Electromagnetic compatibility (EMC) - Part 3-3: Limits - Limitation of voltage changes, voltage fluctuations and flicker in public low-voltage supply systems, for equipment with rated current ≤ 16 A per phase and not subject to conditional connection.
- EN 61547:** Equipment for general lighting purposes - EMC immunity requirements.

LVD Directive 2014/35/EU LOW VOLTAGE

- EN IEC 60598-1** Luminaires - Part 1: General requirements and tests.
- EN IEC 60598-2-1** Luminaires - Part 2-1: Particular requirements - Fixed general purpose luminaires

RoHS Directive 2011/65/EU and Delegated Directive (EU) 2015/863

Determination of certain substances in electrotechnical products.

- IEC 62321-1** **IEC 62321-3-1**
- IEC 62321-4** **IEC 62321-5**
- IEC 62321-6** **IEC 62321-7-1**
- IEC62321-7-2** **IEC 62321-8**

