

**200500NWDIM**

**ROUND RECESSED DIMMABLE  
LED DOWNLIGHT 5W 4500K  
WHITE**



## PRODUCT SPECIFICATIONS

Item code:	200500NWDIM
Description:	Recessed round LED downlight
EAN13 code:	8436568448947

## ELECTRICAL DATA

Power:	5w
Voltage:	200/250vac
Frequency:	50/60Hz
Overvoltage protection:	2 kv
Power factor:	0,9
Dimmable:	YES
Dimming system:	TRIAC
Electrical insulation class:	CLASS II
Connection:	L/N

## LUMINOUS DATA

Color temperature:	4500K
Luminous efficiency:	98 lm/w
Lumens:	490lm
LED chip brand:	San'an
LED chip model:	SMD2835
Beam angle:	180°
Luminous distribution:	Symmetrical
Color rendering index:	>80
Standard deviation of colour matching:	<6
Luminous maintenance factor:	L95B10
Flicker index:	≤1,0
SVM (Stroboscopic Visibility Measure):	≤0,4

## TECHNICAL DATA

Protection rating:	<b>IP44 (Equipment protected against objects larger than 1 mm and splashing water)</b>
Impact rating:	<b>IK06 (1J)</b>
Operating temperature:	<b>-20°~50°</b>
Mounting type:	<b>Recessed mounting</b>

## AVERAGE LIFESPAN

Working hours:	<b>40000 hrs</b>
Switch cycles:	<b>35000 ON/OFF</b>

## PHYSICAL DATA

<b>Housing</b>	
Material:	<b>Aluminium</b>
Finish:	<b>White</b>
<b>Diffuser</b>	
Material:	<b>Polycarbonate</b>
Finish:	<b>Opal</b>
<b>Weight</b>	
Weight:	<b>0,10 kg</b>

## ENERGY EFFICIENCY 2023(UE-2019/2015)

**F**

## DIMENSIONS

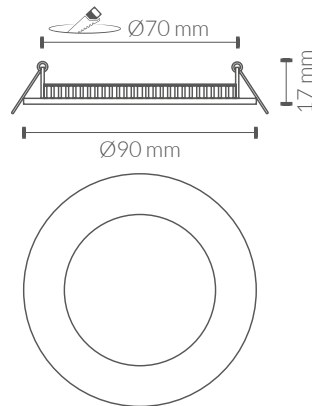

## LUMINOUS INTENSITY DISTRIBUTION CURVE

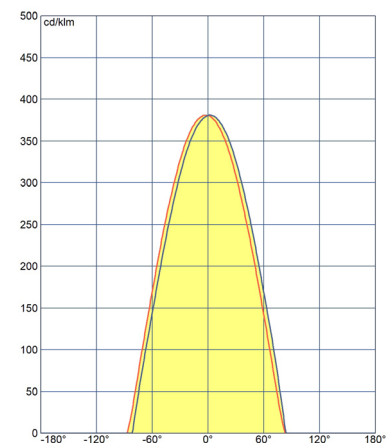
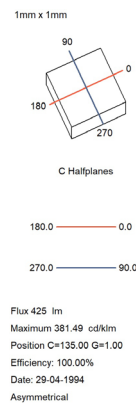
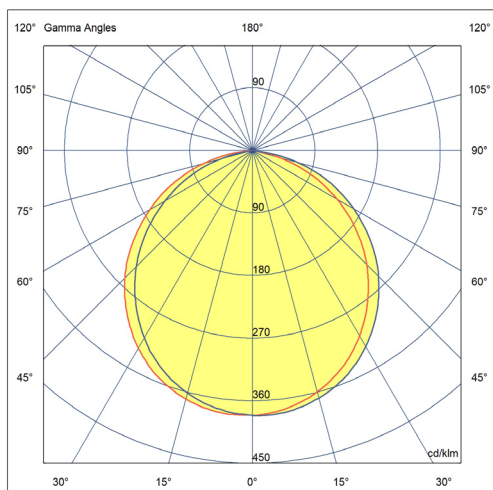
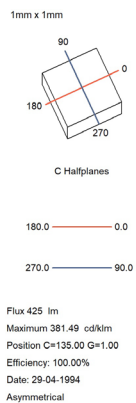

**EMC Directive 2014/30/EU ELECTROMAGNETIC COMPATIBILITY**

- EN IEC 55015** Limits and methods of measurement of radio disturbance characteristics of electrical lighting and similar equipment.
- EN IEC 61000-3-2** Electromagnetic compatibility (EMC) - Part 3-2: Limits - Limits for harmonic current emissions (equipment input current =16 A per phase).
- EN 61000-3-3** Electromagnetic compatibility (EMC) - Part 3-3: Limits - Limitation of voltage changes, voltage fluctuations and flicker in public low-voltage supply systems, for equipment with rated current  $\leq 16$  A per phase and not subject to conditional connection.
- EN 61547:** Equipment for general lighting purposes - EMC immunity requirements.

**LVD Directive 2014/35/EU LOW VOLTAGE**

- EN IEC 60598-1** Luminaires - Part 1: General requirements and tests.
- EN IEC 60598-2-1** Luminaires - Part 2-1: Particular requirements - Fixed general purpose luminaires

**RoHS Directive 2011/65/EU and Delegated Directive (EU) 2015/863**

Determination of certain substances in electrotechnical products.

- |                     |                      |
|---------------------|----------------------|
| <b>IEC 62321-1</b>  | <b>IEC 62321-3-1</b> |
| <b>IEC 62321-4</b>  | <b>IEC 62321-5</b>   |
| <b>IEC 62321-6</b>  | <b>IEC 62321-7-1</b> |
| <b>IEC62321-7-2</b> | <b>IEC 62321-8</b>   |

