

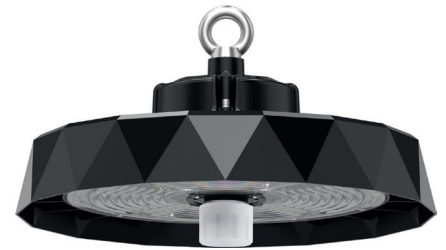

9620001340SNW



UFO INDUSTRIAL HIGH BAY LED LIGHT ASTRAL DIMMABLE WITH MERRYTEK MC079D 99Z SENSOR AND ON/STAND-BY FUNCTION 200W 4000K 90°



UFO Industrial High Bay LED Light Astral with Merrytek MC079D 99Z microwave sensor and ON/STAND-BY function, 200w power and luminosity of 32200lm. Equipped with 320pcs of Lumileds LED chips and dimmable Sosen driver SS-200CNL-260BH series, with 6kv surge protection. Symmetrical optical opening of 90° and color temperature of 4000K. Protection rating against external elements IP65 and mechanical impact resistance rating IK08. Black aluminium body and transparent polycarbonate diffuser.

PRODUCT SPECIFICATIONS

Item code:	9620001340SNW
Description:	Industrial high bay LED light
EAN13 code:	8436568448602

ELECTRICAL DATA

Power:	200W
Voltage:	90-305vac
Frequency:	50-60Hz
Power factor:	0,9
Dimmable:	YES
Driver model:	SOSEN SS-120CNL-130BH series
Dimming system:	0-10v, PWM, Resistor
Driver Protection:	OVP, SCP, OPP, OTP
Overvoltage protection:	6kv
Electrical insulation class:	CLASS I
Connection:	L/N+TT

LUMINOUS DATA

Color temperature:	4000K
Luminous efficiency:	161lm/w
Lumens:	32200lm
LED chip brand:	Lumileds

LED chip model:	Luxeon 3030 2d
Number of LED chips:	320pcs
Beam angle:	90°
Luminous distribution:	Symmetrical
Color rendering index:	>80
Color rendering index, minimum:	80
Color rendering index, maximum:	85
Standard desviation of colour matching:	<6
Luminous flux maintenance:	L90
Flicker index:	≤1,0
SVM (Stroboscopic Visibility Measure):	≤0,4
Flicker free:	YES

MOTION SENSOR DATA

Sensor brand:	MerrYTEK Serie MC079D 99Z
Sensor type:	Microwave
Work mode:	ON/OFF Function ON/Stand by Function ON/Stand-by/OFF Function Daylight Priority function
Configuration options:	YES
Control system:	Remote control MH17
Brightness dimming:	0% (0,5V) - 100% (10V)
Dimming levels:	10% (1.4-1.6V), 20% (1.9-2.1V), 30% (2.9-3.1V), 50% (4.9-5.1V)
Hold time:	5sg, 30sg, 1min, 3min, 5min, 10min, 20min, 30min
Stand-by brightness control:	10%, 20%, 30%, 50%
Stand by hold time :	0sg, 1min, 30min, infinite
Detection area:	100%, 75%, 50%, 25%
Light sensor:	5lux, 15lux, 30lux, 50lux, 100lux, 150lux, disabled
Daylight priority:	ON: 5lux, 15lux, 30lux, 50lux 100lux, 150lux OFF: 150lux, 200Lux, 300lux
Detection range:	D12 Meters (ceiling mounting)
Mounting height:	12mts (máx. 15 mts)

TECHNICAL DATA

Protection rating:	IP65 (Dust-tight and protected against water jets)
Impact rating:	IK08 (5J)
Operating temperature:	-20°~50°
Mounting type:	Suspension

AVERAGE LIFESPAN

Working hours:	55000 hrs
Switching cycles:	40000 ON/OFF

PHYSICAL DATA

Housing	
Material:	Aluminum
Finish:	Preto
Diffuser	
Material:	Polycarbonate
Finish:	Transparent
Weight	
Weight:	4,00 kg

ENERGY EFFICIENCY 2023(UE-2019/2015)

C

DIMENSIONS

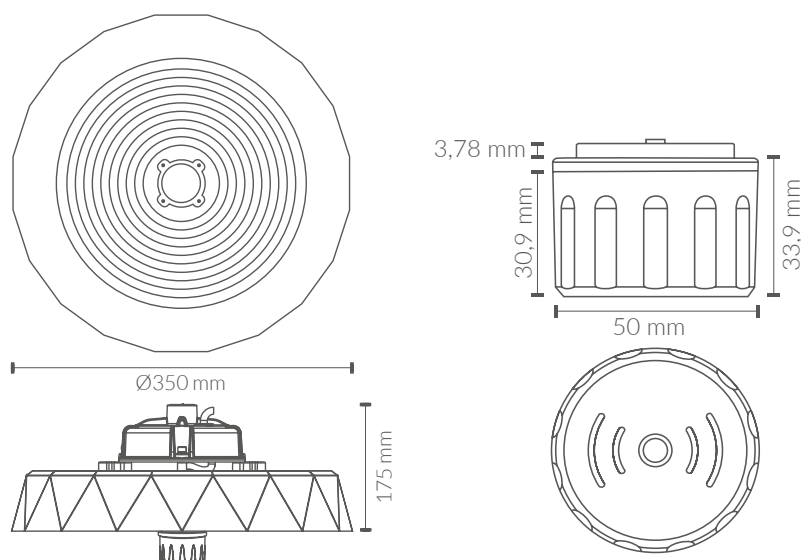



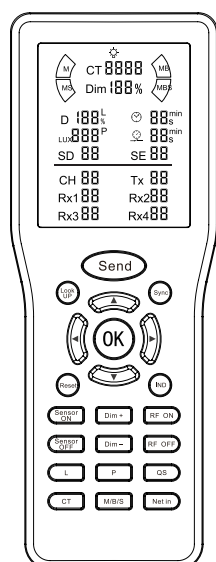





















CONTROL FUNCTIONS







IMPORTANT: Some buttons and functions of the MH17 remote described below are NOT enabled for this luminaire and/or sensor model.

BUTTON	FUNCTION	OPERATING MODE
Send	Screen activation	Short press to activate the screen when it is off.
	One click for parameter transmission	Short press to transmit all parameters shown on the screen. The transmission lasts between 3 and 5 seconds. During this time, point the remote at the sensor. The luminaire will flash once if the transmission is successful.
OK	Transmit a single parameter	Short press to transmit the parameter flashing on the screen. The light will flash once after successful transmission.

BUTTON	FUNCTION	OPERATING MODE																																				
	Parameters and configuration	<p>Press “” to select the parameter, and press “” to select the desired value.</p> <p>1. General parameters:</p> <table border="1"> <thead> <tr> <th>Icon</th> <th>Parameters</th> <th>Options</th> </tr> </thead> <tbody> <tr> <td>D</td> <td>Detection sensitivity</td> <td>100% / 75% / 50% / 25%</td> </tr> <tr> <td>LUX</td> <td>Daylight sensor</td> <td>5lx / 15lux / 30lux / 50lux / 100lux / 150lx or disabled (999)</td> </tr> <tr> <td>SD</td> <td>Stand-by dimming level</td> <td>15% / 20% / 30% / 50%</td> </tr> <tr> <td></td> <td>Hold time</td> <td>5s / 30s / 1min / 3min / 5min / 10min / 20min / 30 min</td> </tr> <tr> <td></td> <td>Stand-by period</td> <td>0s / 10s / 1min / 3min / 5min / 10min / 30min/</td> </tr> </tbody> </table> <p>2. Wireless group parameters:</p> <table border="1"> <thead> <tr> <th>Icon</th> <th>Parameters</th> <th>Options</th> </tr> </thead> <tbody> <tr> <td>Tx</td> <td>Transmitter (the master device transmits the group code)</td> <td>A total of 16 groups can be configured from 00 to 15, and sensors in the same group can be connected to each other.</td> </tr> <tr> <td>Rx1 Rx2 Rx4 Rx3</td> <td>Receiver (slave device that receives the group code)</td> <td>16 groups can be configured, from 00 to 15, respectively, and wireless signals with the same group code as the transmitter can be received.</td> </tr> </tbody> </table> <p>3. Other parameters (Not applicable to MC, MLC series)</p> <table border="1"> <thead> <tr> <th>Icon</th> <th>Parameters</th> <th>Options</th> </tr> </thead> <tbody> <tr> <td>SE</td> <td>Scene selector</td> <td>Up to a total of 10 scenes can be configured, from 01 to 10.</td> </tr> <tr> <td>CH</td> <td>Channels</td> <td>Up to a total of 30 channels can be configured, from 01 to 30.</td> </tr> </tbody> </table>	Icon	Parameters	Options	D	Detection sensitivity	100% / 75% / 50% / 25%	LUX	Daylight sensor	5lx / 15lux / 30lux / 50lux / 100lux / 150lx or disabled (999)	SD	Stand-by dimming level	15% / 20% / 30% / 50%		Hold time	5s / 30s / 1min / 3min / 5min / 10min / 20min / 30 min		Stand-by period	0s / 10s / 1min / 3min / 5min / 10min / 30min/	Icon	Parameters	Options	Tx	Transmitter (the master device transmits the group code)	A total of 16 groups can be configured from 00 to 15, and sensors in the same group can be connected to each other.	Rx1 Rx2 Rx4 Rx3	Receiver (slave device that receives the group code)	16 groups can be configured, from 00 to 15, respectively, and wireless signals with the same group code as the transmitter can be received.	Icon	Parameters	Options	SE	Scene selector	Up to a total of 10 scenes can be configured, from 01 to 10.	CH	Channels	Up to a total of 30 channels can be configured, from 01 to 30.
		Icon	Parameters	Options																																		
		D	Detection sensitivity	100% / 75% / 50% / 25%																																		
		LUX	Daylight sensor	5lx / 15lux / 30lux / 50lux / 100lux / 150lx or disabled (999)																																		
		SD	Stand-by dimming level	15% / 20% / 30% / 50%																																		
			Hold time	5s / 30s / 1min / 3min / 5min / 10min / 20min / 30 min																																		
			Stand-by period	0s / 10s / 1min / 3min / 5min / 10min / 30min/																																		
		Icon	Parameters	Options																																		
		Tx	Transmitter (the master device transmits the group code)	A total of 16 groups can be configured from 00 to 15, and sensors in the same group can be connected to each other.																																		
		Rx1 Rx2 Rx4 Rx3	Receiver (slave device that receives the group code)	16 groups can be configured, from 00 to 15, respectively, and wireless signals with the same group code as the transmitter can be received.																																		
Icon	Parameters	Options																																				
SE	Scene selector	Up to a total of 10 scenes can be configured, from 01 to 10.																																				
CH	Channels	Up to a total of 30 channels can be configured, from 01 to 30.																																				
	Low sensitivity mode	Briefly press to activate low sensitivity mode for a single product. The screen will display “L” and the luminaire will flash once after configuration. This mode can be applied in highly reflective environments where the sensor cannot turn off the light.																																				
	Enable daylight priority mode ----- Daylight harvesting	<p>Briefly press and the screen will display “P” to activate daylight priority mode. The lamp will flash once after configuration. The lamp will turn on when the lux level is below the preset turn-on value and will turn off when it exceeds the preset turn-off value.</p> <table border="1"> <thead> <tr> <th>Settings</th> <th>ON - Daylight below</th> <th>OFF - Daylight override</th> </tr> </thead> <tbody> <tr> <td>5lux / 15lux 30lux / 50lux</td> <td>5lux / 15lux 30lux / 50lux</td> <td>150lux</td> </tr> <tr> <td>100lux</td> <td>100lux</td> <td>200lux</td> </tr> <tr> <td>150lux</td> <td>150lux</td> <td>300lux</td> </tr> </tbody> </table> <p>Hold the button and the screen will display “P” to activate the daylight harvesting mode. The lamp will flash three times after configuration. The desired illumination level for the floor or desk can be selected, and the lamp will adjust according to natural light. Optional settings are 100 lux, 200 lux, 300 lux, 400 lux, 500 lux, 600 lux, and 999 lux (999 will not dim). Briefly press “P” to exit daylight priority mode or daylight harvesting mode. The lamp will flash once. “P” will no longer be displayed on the screen.</p>	Settings	ON - Daylight below	OFF - Daylight override	5lux / 15lux 30lux / 50lux	5lux / 15lux 30lux / 50lux	150lux	100lux	100lux	200lux	150lux	150lux	300lux																								
Settings	ON - Daylight below	OFF - Daylight override																																				
5lux / 15lux 30lux / 50lux	5lux / 15lux 30lux / 50lux	150lux																																				
100lux	100lux	200lux																																				
150lux	150lux	300lux																																				

BUTTON	FUNCTION	OPERATING MODE
 	Dimming level	<p>Short press  to increase the light intensity by 2 % each time. Long press to increase the brightness continuously.</p> <p>Short press  to decrease the light intensity by 2 % each time. Long press to decrease the brightness continuously, with a minimum brightness of 15 % (the minimum brightness of some products can be adjusted to 50 %). Check the product for more information.</p>
	Quick setup	<p>Hold to save the parameters displayed on the screen in Quick Setup mode. To quickly configure a lamp's parameters, briefly press this button to recall the saved parameters. Then, briefly press  to quickly set each parameter. The light will flash once the configuration is complete.</p>
	Deactivate sensor mode ----- Light permanently off	Briefly press to deactivate the sensor function. The light will flash once after configuration. If there are multiple luminaires in the same group, briefly press to deactivate the sensor function for all products in that group. Press and hold to turn off the light. If there are multiple lights in the same group, all will turn off.
	Activate sensor mode ----- Light permanently on	Briefly press to restore the sensor function. The light will flash once after successful configuration, and the sensor parameters will be the last set values. If there are multiple products in the same group, briefly press to activate the sensor function on all products in that group. Press and hold to turn on the light. If there are multiple lights in the same group, all will turn on.
	Reset	Briefly press to reset the sensor, and the light will flash once, restoring the sensor parameters to the factory default settings.
	Turn the screen backlight on or off	Long press to turn the screen backlight on or off. Short press to turn the sensor indicator on or off (if available).
	Enable wireless configuration function ----- Wireless network function	Hold the remote control to open the wireless configuration options. Briefly press to activate the wireless network function. After successful configuration, the light will flash once.
	Disable wireless configuration function ----- Wireless network	Hold the remote control to close the wireless configuration. Briefly press to deactivate the wireless network function. After successful configuration, the light will flash once.
	Check	<p>Short press to check the specific configuration of the current wireless sensor parameters. After a successful check, the sensor will flash once and the screen will display all detection and network parameters of the sensor.</p> <p>Note:</p> <ol style="list-style-type: none"> 1. After each check, wait 5 seconds before performing a new one. 2. Sensors without wireless network function do not allow parameter checking.

BUTTON	FUNCTION	OPERATING MODE
	Synchronize	Short press to synchronize the current sensor parameter settings with other sensors in the same group (network parameters cannot be synchronized). The synchronization process lasts 3 to 5 seconds; during this time, make sure the remote control is pointed at the sensor. Once synchronization is successfully completed, the luminaires in the same group will flash three times.
	Network pairing	For sensors with Bluetooth or ZigBee network function, hold this button to put the sensor into pairing mode; the luminaire will flash.
	Color temperature control	Short press to adjust the color temperature, if the sensor supports color temperature control. Color temperature options: 2700K / 3000K / 3500K / 4000K / 4500K / 5000K.
	Change sensor mode	Short press to change the sensor mode (if the sensor supports the corresponding modes). M: motion mode. MS: motion + micro-motion. MB: motion + breathing. MBS: motion + micro-motion + breathing.

LUMINOUS INTENSITY DISTRIBUTION CURVE

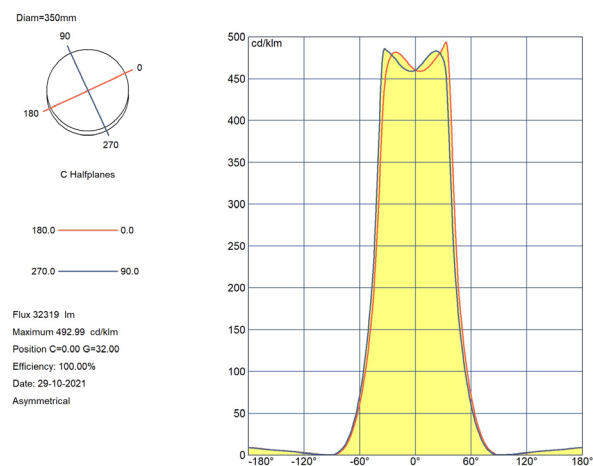
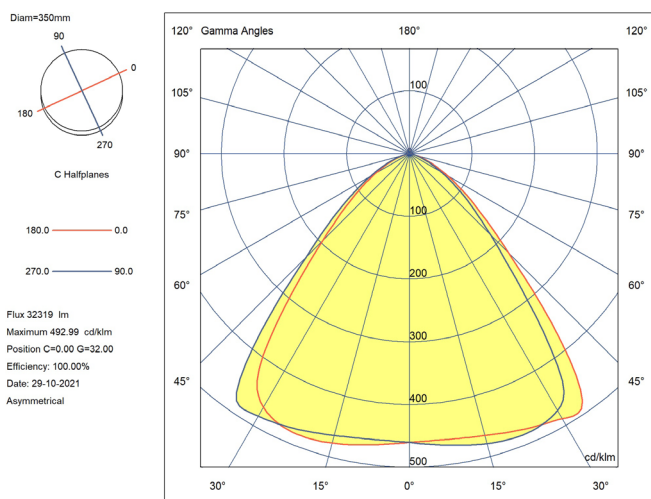

CERTIFICATIONS

CE & ROHS

EMC directive 2014/30/EU ELECTROMAGNETIC COMPATIBILITY

- EN IEC 55015** Limits and methods of measurement of radio disturbance characteristics of electrical lighting and similar equipment.
- EN 61547** Equipment for general lighting purposes - EMC immunity requirements.
- EN IEC 61000-3-2** Electromagnetic compatibility (EMC) - Part 3-2: Limits - Limits for harmonic current emissions (equipment input current =16 A per phase).
- EN 61000-3-3** Electromagnetic compatibility (EMC) - Part 3-3: Limits - Limitation of voltage changes, voltage fluctuations and flicker in public low-voltage supply systems, for equipment with rated current ≤ 16 A per phase and not subject to conditional connection.

LVD directive 2014/35/EU LOW VOLTAGE

EN IEC 60598-2-1 Luminaires - Part 2-1: Particular requirements - Fixed general purpose luminaires

EN IEC 60598-1 Luminaires - Part 1: General requirements and tests.

EN 62493 Assessment of lighting equipment related to human exposure to electromagnetic fields

EN IEC 62031 LED modules for general lighting - Safety specifications

RoHS Directive 2011/65/EU and Delegated Directive (EU) 2015/863

Determination of Certain Substances in Electrotechnical Products.



IEC 62321-3-1 **IEC 62321-5**

IEC 62321-4 **IEC 62321-6**

IEC 62321-7-2 **IEC 62321-8**