

## 96200120CCT

### CAMPÂNULA LED UFO MULTIPOTÊNCIA E CCT SURYA 200W/150W/120W 120°

Campânula industrial LED UFO multipotência e CCT Surya, campânula com seletor de potência de 200W, 150W e 120W e eficiência luminosa de 170lm/W. Equipada com 502pcs de chips LED Lumileds e driver MOSO série G6T-III com proteção contra sobretensão de 6kV. Abertura ótica simétrica de 120° e seletor de temperatura de cor: 5700K, 4000K e 3000K. Grau de proteção contra elementos externos IP65 e grau de proteção de resistência mecânica a impactos IK08. Corpo em alumínio preto e difusor de policarbonato transparente.



#### DADOS DO PRODUTO

Código do artigo:	96200120CCT
Descrição:	Campânula industrial LED
Código EAN13:	8435724907335

#### DADOS ELÉTRICOS

Potência:	Selecionável: 120W / 150W / 200W
Sistema de seleção:	Seletor interno no driver
Tensão:	90-305vac
Hertz:	50-60Hz
Modelo do driver:	MOSO serie G6T-III
Fator de potência:	0,9
Regulável:	NÃO
Certificação ENEC:	SIM
Protecciones del driver:	OVP, SCP, OTP
Proteção contra sobretensão:	6kv
Classe de isolamento elétrico:	CLASSE I
Conexão:	L/N+TT

#### DADOS LUMÍNICOS

Temperatura de cor:	CCT Selecionável: 5700K / 4000K / 3000K
Sistema de seleção:	Seletor interno no driver
Eficiência luminosa:	170lm/w
Lúmenes:	20400lm (120W) / 25500lm (150W) / 34000lm (200W)
Marca LED chip:	Lumileds
Modelo LED chip:	Luxeon 3030 2d
N.º de LED chip:	502pcs

Ângulo de abertura:	120°
Distribuição luminosa:	Simétrica
Índice de reprodução cromática:	>80
Desviopadrão de correspondência de cor:	<4
Manutenção do fluxo luminoso:	L95B10
Índice de cintilação:	≤1,0
Medida de visibilidade do efeito estroboscópico:	≤0,4
Flicker free:	SIM

## DADOS TÉCNICOS

Grau de proteção:	IP65 (Equipamento hermético ao pó e protegido contra jatos de água)
Grau de impacto:	IK08 (5J)
Temperatura de trabalho:	-20°~50°
Tipo de montagem:	Suspensão

## VIDA MEDIA

Horas de vida:	45000 hrs
Ligadas:	35000 ON/OFF

## DADOS FÍSICOS

### Corpo da luminária

Material:	Alumínio
Acabamento:	Preto

### Difusor

Material:	Policarbonato
Acabamento:	Transparente

### Peso

Peso:	1,70 kg
-------	---------

## EFICIÊNCIA ENERGÉTICA 2023(UE-2019/2015)

C

## MEDIDAS

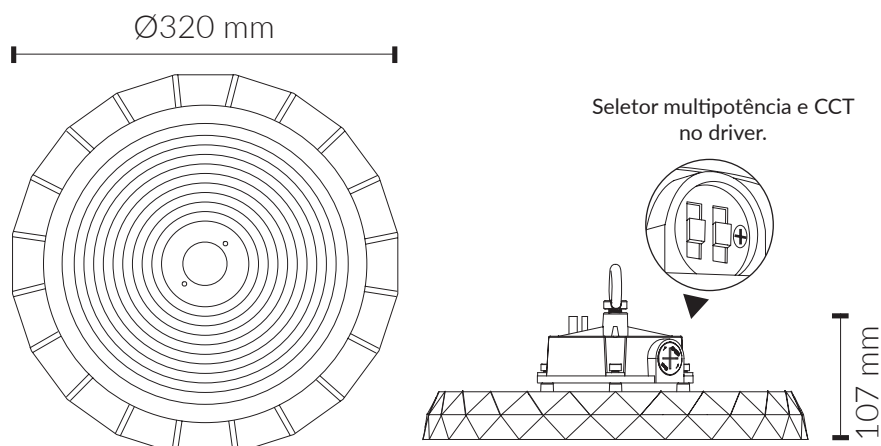

# CURVA DE DISTRIBUCIÓN DE INTENSIDAD LUMINOSA

## 120W - 5700K

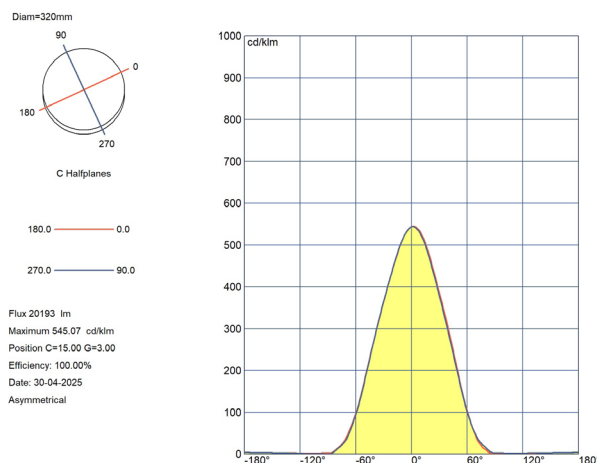
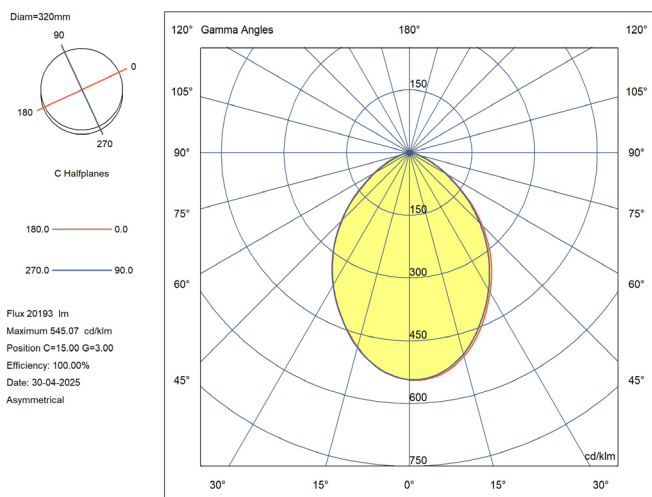

## 120W - 4000K

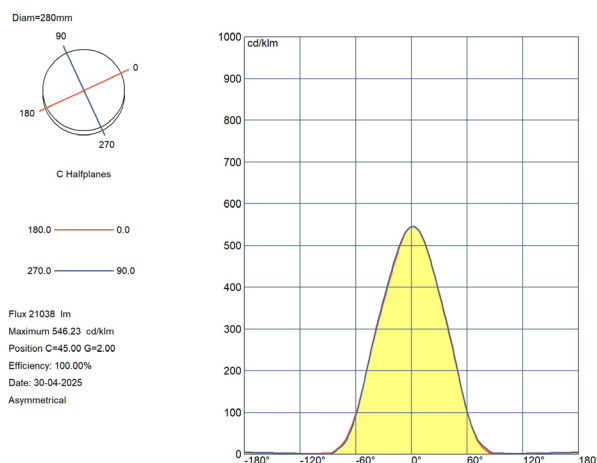
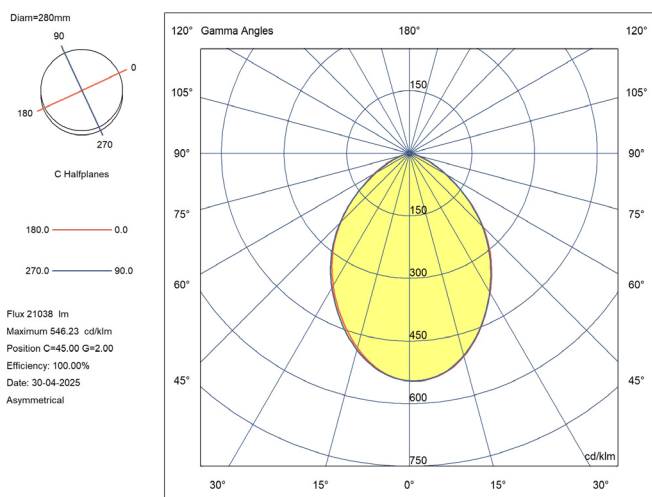

## 120W - 3000K

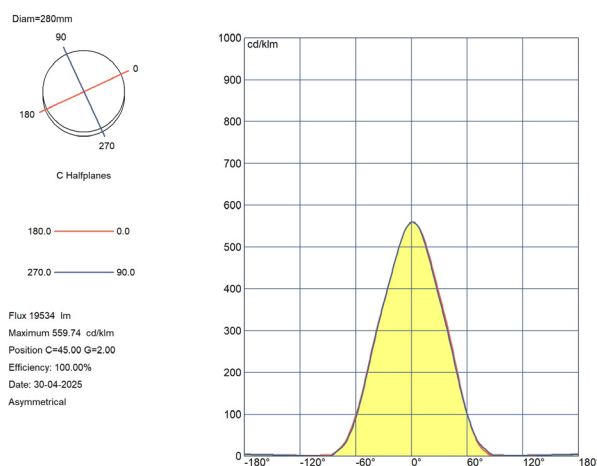
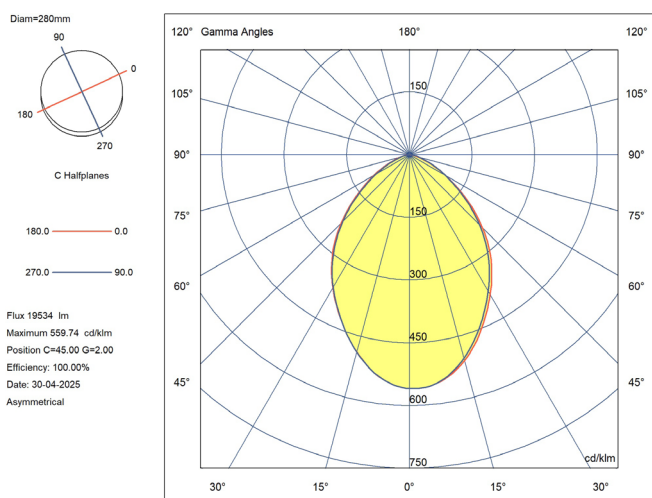

# 150W - 5700K

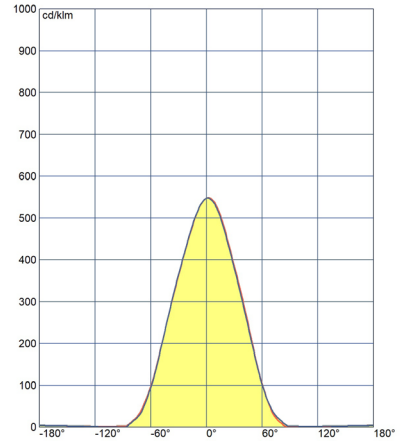
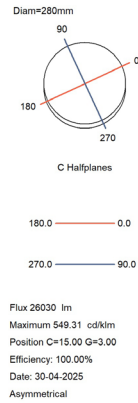
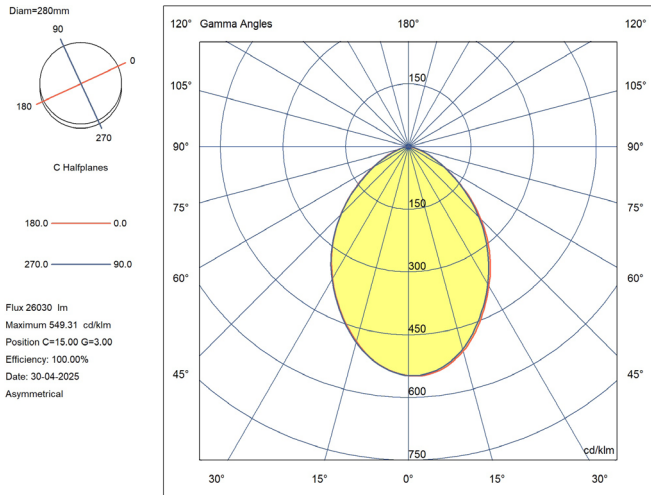

# 150W - 4000K

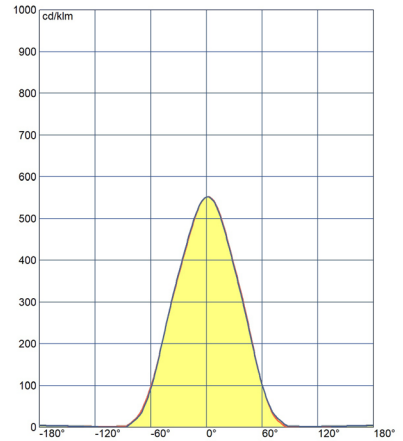
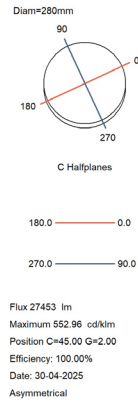
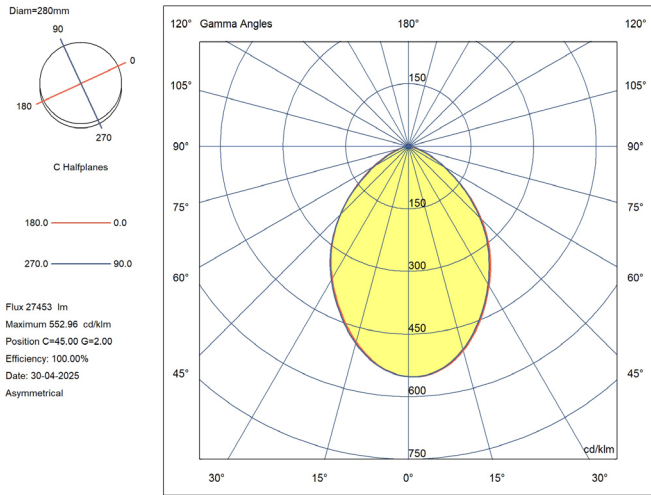

# 150W - 3000K

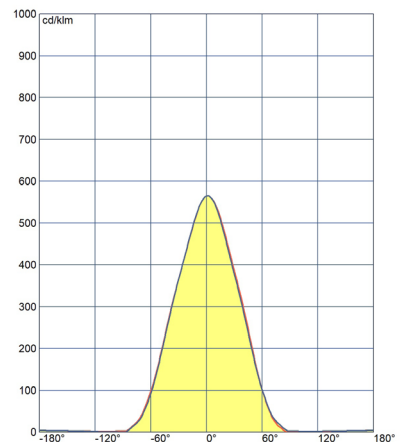
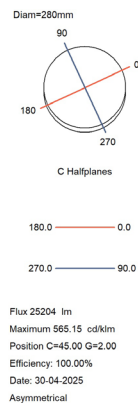
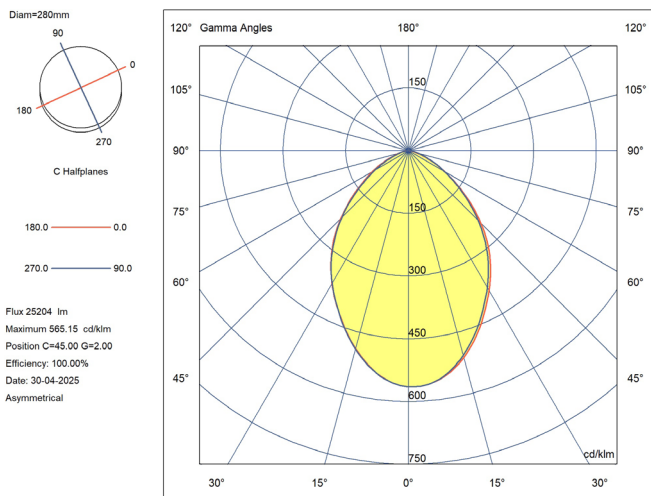

## 200W - 5700K

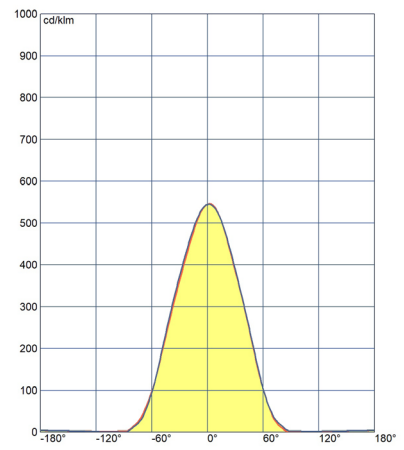
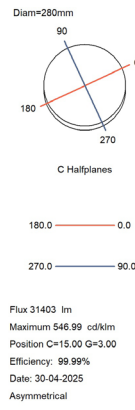
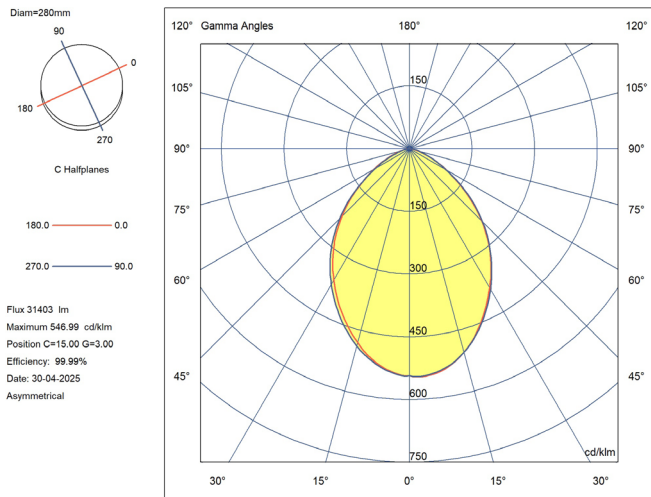

## 200W - 4000K

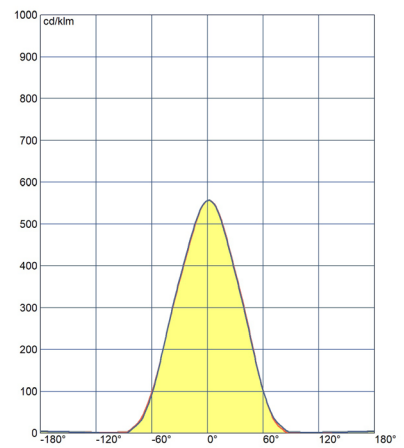
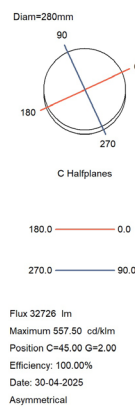
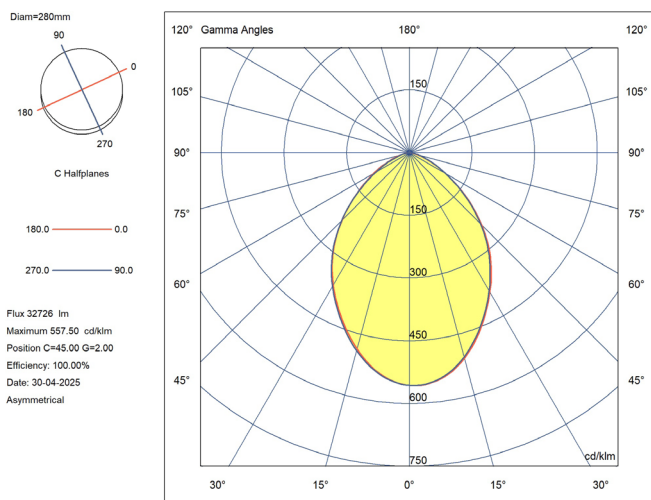

## 200W - 3000K

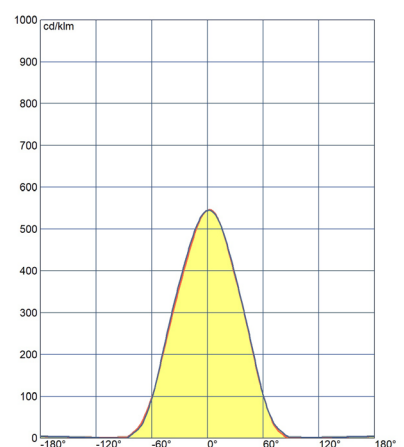
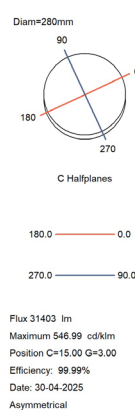
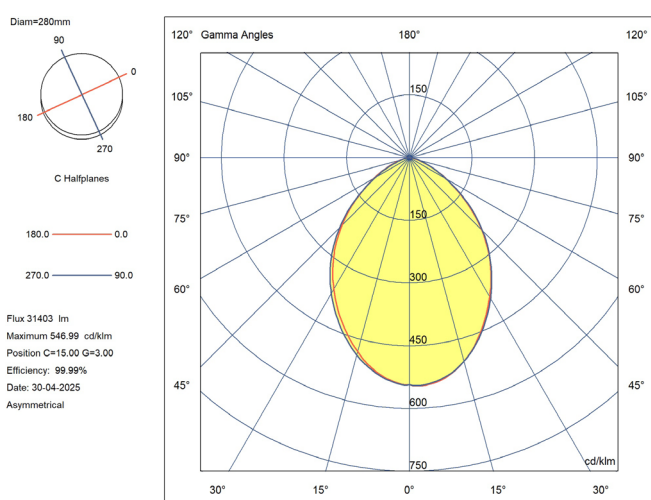

## CERTIFICAÇÕES

