

880800CCT

ATENAS OUTDOOR WALL LIGHT 30W CCT

ATENAS wall light, surface-mounted installation and suitable for outdoor use with IP54 protection rating. 30W power and 3300lm luminous flux. Direct lighting with 120° symmetrical optical opening and 3 selectable colour temperatures via DIP switch. IK09 mechanical impact resistance rating. White finish aluminium body and opal polycarbonate diffuser.



PRODUCT SPECIFICATIONS

Item code:	880800CCT
Description:	ATENAS outdoor wall light
EAN13 code:	8436568447100

ELECTRICAL DATA

Power:	30w
Voltage:	170-265vac
Frequency:	50/60 Hz
Power factor:	0,9
Dimmable:	NOT
Electrical insulation class:	CLASS II
Connection:	L/N

LUMINOUS DATA

Color temperature:	Selectable CCT 5700K/4000K/2700K
Luminous efficiency:	110 lm/w
Selection system:	DIP switch
Lumens:	3300lm
LED chip model:	SMD 2835
Beam angle:	120°
Luminous distribution:	Symmetrical
Color rendering index:	>80
Color rendering index (Minimum value):	80
Color rendering index (Maximum value):	83

Standard desviation of colour matching:	<4
Luminous maintenance factor:	L90
Flicker index:	≤1,0
SVM (Stroboscopic Visibility Measure):	≤0,4

DATOS TÉCNICOS

Protection rating:	IP54 (Equipment protected against dust and water splashes)
Impact rating:	IK09 (10J)
Operating temperature:	-20°~50°
Mounting type:	Surface-mounted

AVERAGE LIFESPAN

Working hours:	35000 hrs
Switch cycles:	25000 ON/OFF

PHYSICAL DATA

Housing	
Material:	Aluminum
Finish:	White
Diffuser	
Material:	Polycarbonate
Finish:	Opal

ENERGY EFFICIENCY 2023(UE-2019/2015)

F

DIMENSIONS

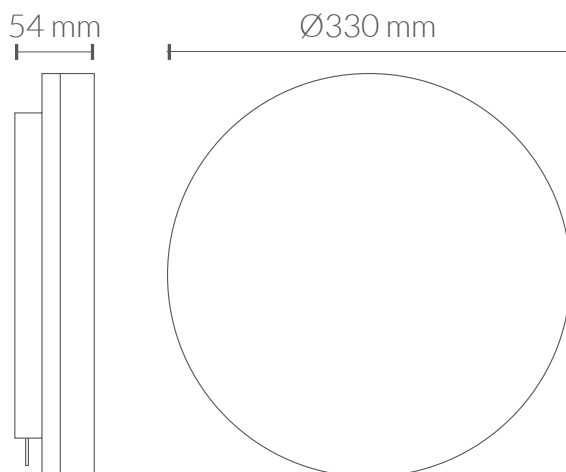

LUMINOUS INTENSITY DISTRIBUTION CURVE

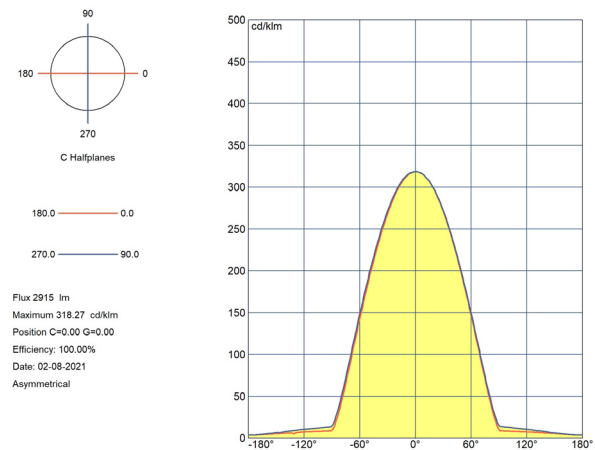
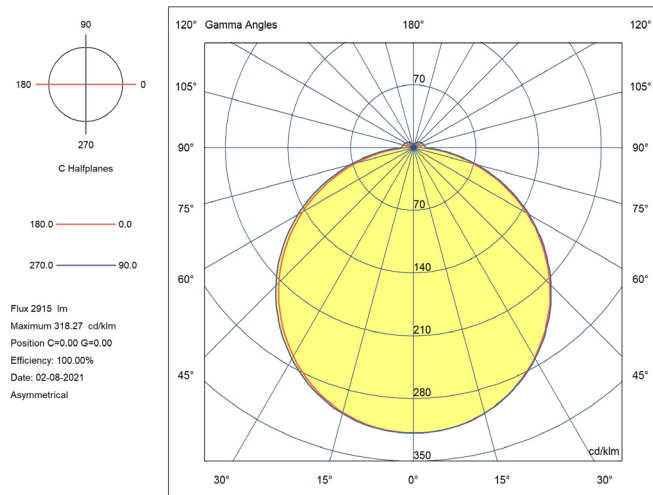

CERTIFICATIONS

CE & ROHS

EMC Directive 2014/30/EU ELECTROMAGNETIC COMPATIBILITY

- EN IEC 55015** Limits and methods of measurement of radio disturbance characteristics of electrical lighting and similar equipment.
- EN IEC 61000-3-2** Electromagnetic compatibility (EMC) - Part 3-2: Limits - Limits for harmonic current emissions (equipment input current = 16 A per phase).
- EN 61000-3-3** Electromagnetic compatibility (EMC) - Part 3-3: Limits - Limitation of voltage changes, voltage fluctuations and flicker in public low-voltage supply systems, for equipment with rated current ≤ 16 A per phase and not subject to conditional connection.
- EN 61547:** Equipment for general lighting purposes - EMC immunity requirements.

LVD Directive 2014/35/EU LOW VOLTAGE

- EN IEC 60598-1** Luminaires - Part 1: General requirements and tests.
- EN IEC 60598-2-1** Luminaires - Part 2-1: Particular requirements - Fixed general purpose luminaires
- EN 62493** Assessment of lighting equipment related to human exposure to electromagnetic Field

RoHS Directive 2011/65/EU and Delegated Directive (EU) 2015/863

Determination of certain substances in electrotechnical products.

- IEC 62321-4** **EN 62321-3-1**
- EN62321-5** **IEC 62321-7-1**
- IEC 62321-7-2** **EN 62321-6**
- EN 62321-8**

