

## Ficha Técnica



CODIGO	POTÊNCIA	LM	TENÇÃO
711203070NWR	120w	17160lm	90-305vac

### ESPECIFICACIONES TÉCNICAS

Temperatura de Cor	4000k
LED Chip	192pcs 2835SMD
Óptica	100°x130°
Protecção contra sobretensão	5Kv
Montaje	POSTE/COLUNA
Braço direcional	15°
Diámetro de Fijación	68mm
Acabamento	RAL9007 Aluminio Grey
Dimensões	56x29x12,3cm

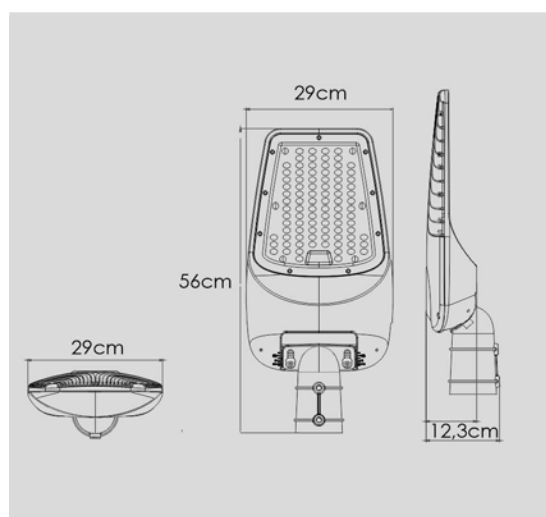

DRIVER REGUL. † - OX6-75

**MOSO**

Regulação 0-10v, PWM, dim to off, cronómetro

Programação off-line

Cronómetro

hk \ u-# ( ^ -o DRIVER

OVP	Proteção contra sobretensão
SCP	Proteção contra curto-circuito
OTP	Proteção contra superaquecimento