

Ficha Técnica



CODIGO	POTÊNCIA	LM	TENÇÃO
711203070CW	120w	17400lm	100-277vac

ESPECIFICACIONES TÉCNICAS

Temperatura de Cor	5700k
LED Chip	192pcs 2835SMD
Óptica	70°x150°
Protecção contra sobretensão	6Kv
Montaje	POSTE/COLUNA
Braço direcional	15°
Diámetro de Fijación	68mm
Acabamento	RAL9007 Aluminio Grey
Dimensões	56x29x12,3cm

100-277vac	6kv	0,9	60.000	40.000	-20° +50°	70°x150°	CRI>80	IP66	Ik09	3,8kg	Aluminio	

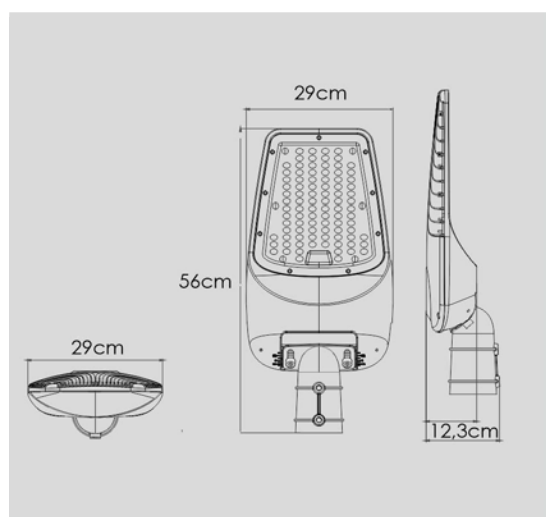

PROTEÇÕES DO DRIVER

OVP	Proteção contra sobretensão
SCP	Proteção contra curto-circuito
OTP	Proteção contra superaquecimento