

Lámpara esférica LED 6w E27 480lm 6000k

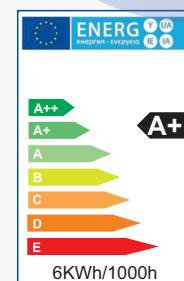
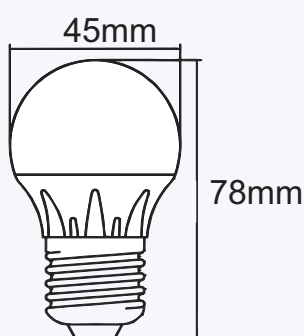

Especificaciones Técnicas

Código	452706CW
Potencia	6w
Casquillo	E27
Tensión	170-240V
Color Temperatura	6000K
Luminosidad	480lm
Equivalencia Incandescencia	55w
Ángulo de Apertura	180°
IRC (índice de reproducción cromática)	> 80
Led Chip	SMD2835
Temperatura de Trabajo	-20°/50°
Factor de Potencia	0.5
Vida Media	30.000hrs
Encendidos	20.000hrs
Material	Termoplástico+ Aluminio
Difusor	Opal
Grado Estanqueidad	IP20
Dimensiones	D:45mm H:78mm
Certificados	CE & RoHS